

STONEBOOK	02	TWIN	36
DRUK UV UV PRINT	03	LINEA	37
ZESTAW NATURA notesy NATURA SET notebooks	04	PENNA JUTA	38
ZESTAW NATURA kalendarze NATURA SET calendars	05	LIMO	39
PENDRIVE 8 GB	06	IDEO	40
ELEMENTY ALUMINIOWE M1/M2/M3 METAL ELEMENTS M1/M2/M3	07	DOPIO	41
ZAMSZ	08	COLORADO	42
CAMO	09	COLORADO RUSTYKALNE PEZZO	43
NATURA	10	FILC	44
NATURA WZÓR/ NATURA PATTERN	11	INSERTO	45
GUMA	12-13	SKÓRA NATURALNA/NATURAL LEATHER ITALIANO	46
WŁÓKNINA TITO	14	SKÓRA NATURALNA/NATURAL LEATHER BIZNES PLUS/CORRIDA	47
TAILOR	15	OUTLET	48-49
RODZINA Z SERII CARBON CARBON FAMILY	16-17	NOTESY NOTEBOOKS	50-53
CARBON PRESTO	18	ZESTAWY PIŚMIENNICZE WRITING SETS	54-55
LATTA	19	ZESTAWY UPOMINKOWE CALENDAR PACKAGING	56-57
BETON	20	PROJEKT AUTORSKI CUSTOMIZED DESIGN	58-59
CEMENTO	21	ŁĄCZENIE OPRAW COVER LAYOUTS	60-61
BOSCO	22	DODATKI ADDS	62-67
DRVO	23	ZESTAWIENIE ROKU YEAR DESIGN	68-70
RODZINA TOSKANIA TOSKANIA FAMILY	24-25	USZLACHTNIENIA DRUKU IMPROVEMENT QUALITY OF PRINT	71
VIVELA	26-27	STONEBOOK-kalendarze STONEBOOK-calendars	72-76
CENTRO	28	STONEBOOK-notesy STONEBOOK-notebooks	77
NOVERO	29	KALENDARZ MIĘDZYNARODOWY INTERNATIONAL CALENDAR	78-79
IMAGE	30-31	BLOKI KALENDARZY CALENDAR LAYOUTS	80-85
TASSO	32	BLOKI NOTESÓW NOTEBOOKS LAYOUTS	86-87
RETTO	33	ZESTAWIENIE BLOKÓW LIST OF CALENDAR BLOCKS	88
CROSS	34-35		

EDYCJA LIMITOWANA  
KALENDARZY  
NOTESÓW  
NA PAPIERZE  
Z KAMIENIA  
LIMITED EDITION  
CALENDARS  
NOTEBOOKS  
ON STONE PAPER

stonebook®

DRUK UV  
NA EKOSKÓRZE  
NA BIAŁYM MATERIALE  
IDEO/IMAGE  
UV PRINT  
PU LEATHER  
ON WHITE MATERIAL  
IDEO/IMAGE

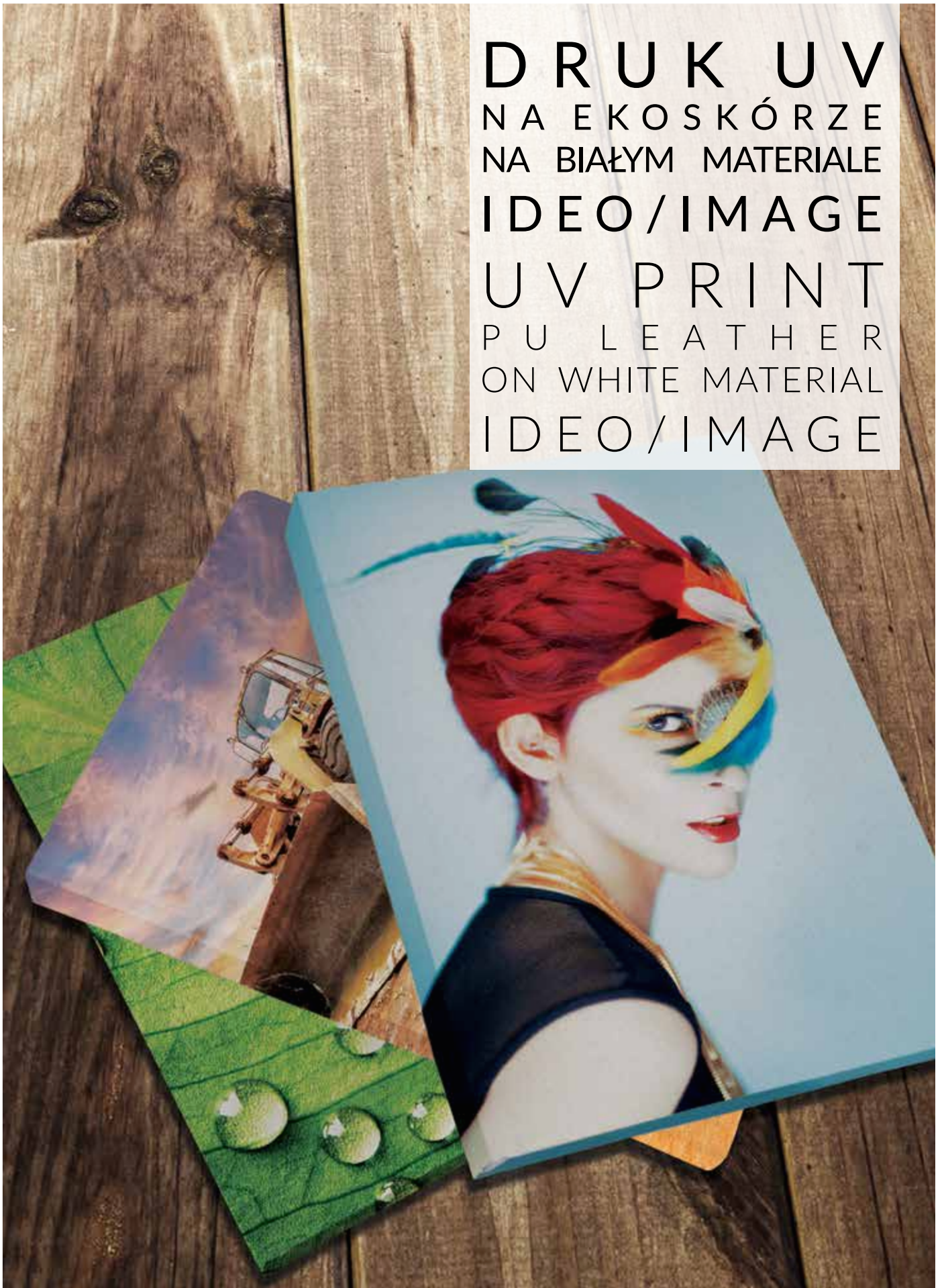



# NOTES A5 OPRAWA NATURA PAPIER Z KAMIENIA NOTEBOOK A5 NATURA COVER STONE PAPER

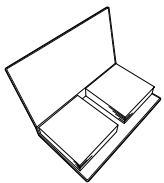

ZESTAW 2 BLOCZKÓW W ETUI/  
2 NOTE CUBE WITH COVER\*  
bez zadruku/plain  
120 stron/120 pages  
wymiar etui/cover dimension:  
158 x 83 mm  
wymiar bloczków/block dimension:  
70 x 70 mm

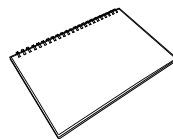

NOTES NA SPIRALI/  
SPIRAL NOTEBOOK  
bez zadruku/plain  
wymiar/dimension:  
136 x 210 mm

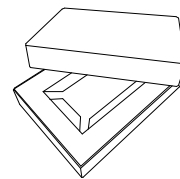

PUDEŁKO/  
PAPER BOX  
wymiar/dimension:  
158 x 220 x 41 mm

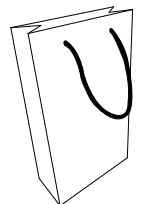

TORBA PAPIEROWA/  
PAPER BAG  
wymiar/dimension:  
178 x 304 x 70 mm

\*maks. wymiar tłoczenia tą samą matrycą/  
max embossing dimension 70 x 100 mm



**KALENDARZ  
OPRAWA NATURA  
BLOK OFFSET  
CALENDAR  
NATURA COVER  
BLOCK OFFSET**

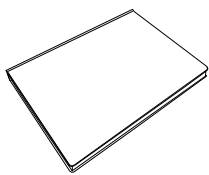

KALENDARZ DZIENNY 503D/  
DAILY CALENDAR 503D  
wymiar/dimension:  
143 x 203 mm

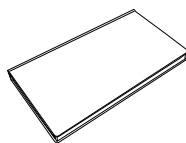

KALENDARZ 504T/  
CALENDAR 504T  
wymiar/dimension:  
85 x 153 mm

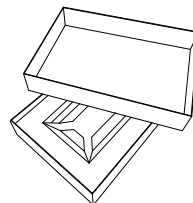

PUDEŁKO/  
PAPER BOX  
wymiar/dimension:  
158 x 220 x 41 mm



TORBA PAPIEROWA/  
PAPER BAG  
wymiar/dimension:  
178 x 304 x 70 mm



**PENDRIVE 8 GB**  
MOCOWANY W OPRAWIE  
**PENDRIVE 8 GB**  
FASTEN TO COVER

MOŻLIWOŚĆ ŁĄCZENIA PENDRIVE'A  
W WYBRANYM MIEJSCU NA BRZEGU  
OPRAWY Z DOWOLNEJ OKLEINY

POSSIBLE TP JOIN PENDRIVE IN ANY  
PLACE AT THE EDGE OF THE COVER

M8

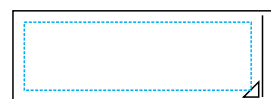

satynowany metal/  
satin metal  
wielkość/size: 34 x 11 mm  
pole graweru/engraving area:  
29 x 9 mm

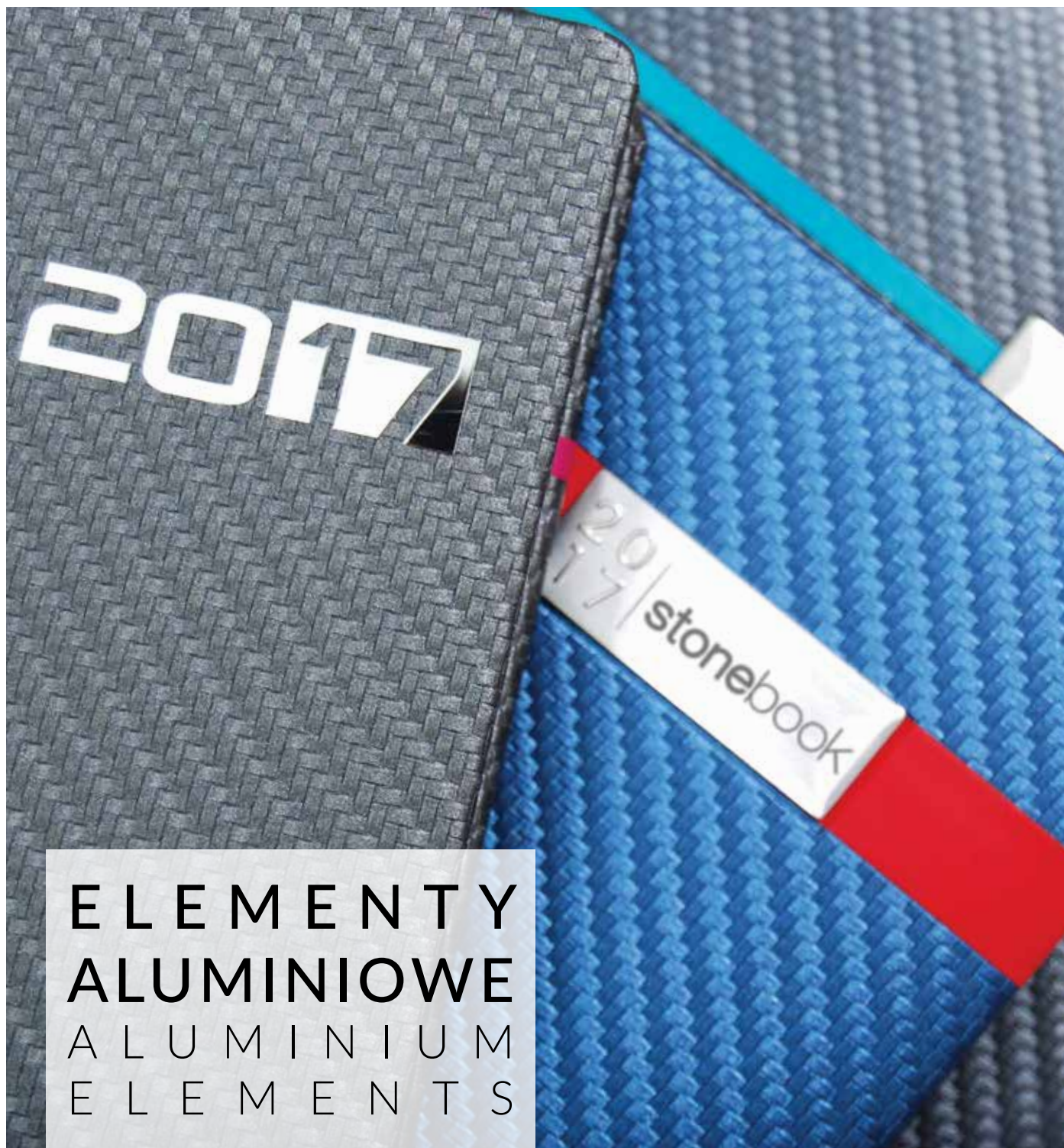

ELEMENTY  
ALUMINIOWE  
ALUMINIUM  
ELEMENTS

M1

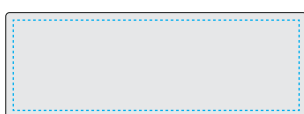

szcztokowane aluminium/  
brush aluminium  
wielkość/size: 40 x 14 mm  
pole graweru/engraving area:  
12 x 38 mm

M2



szcztokowane aluminium z tłoczonym rokiem/  
brush aluminium with embissing year  
wielkość/size: 40 x 14 mm  
pole graweru/engraving area:  
12 x 26 mm

M3



błyszczący metal/  
gloss aluminium  
wielkość/size: 43 x 11 mm

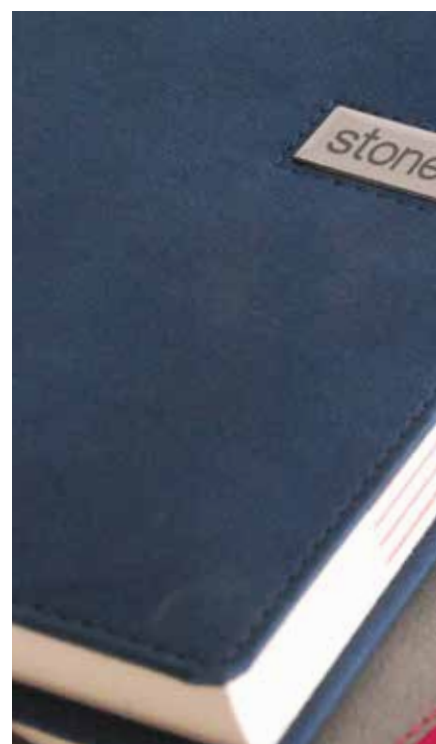

## Z A M S Z

obszycie oprawy  
wariant tłoczenia 16  
struktura zamszu  
miła i ciepła w dotyku

cover sewing  
year embossing 16  
suede structure  
nice in warm in touch

kolorystyka/ colours:

czarny/ black  
szary/ grey  
granatowy/ dark blue





## ZAMSZ + M2

obszycie oprawy  
blaszka metalowa M2

cover sewing  
metal element M2

## C A M O

ZAMSZ + **VIVELA**  
obszycie oprawy  
blaszka metalowa M2

cover sewing  
metal element M2

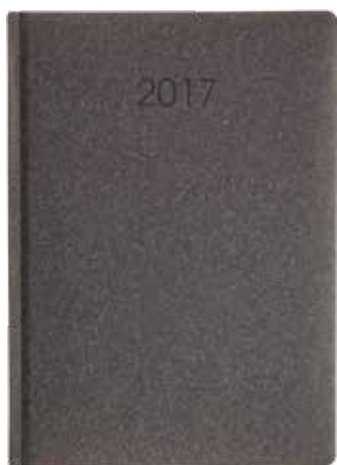
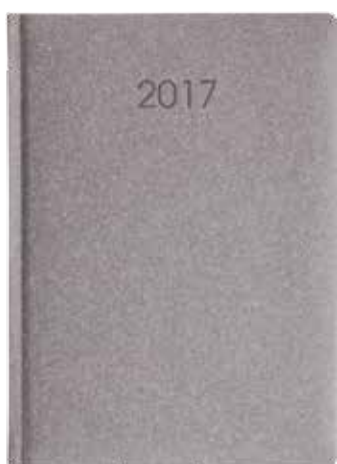
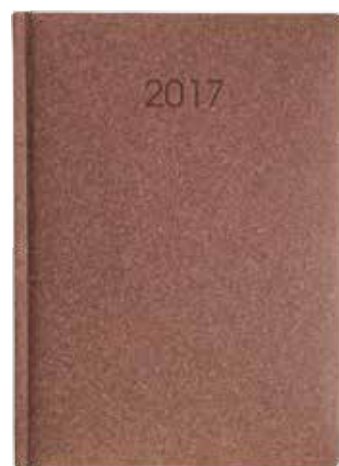
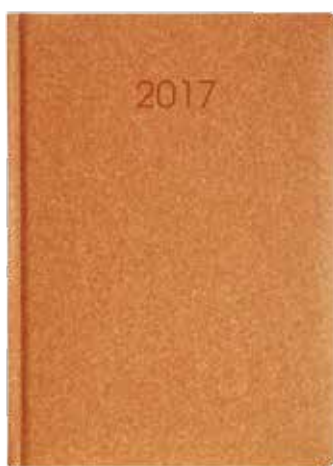

# NATURA

wariant tłoczenia 1  
okleina papierowa FSC

year embossing 1  
paper cover

kolorystyka/ colours:

granatowy/ dark blue  
brązowy/ brown  
czekoladowy/ chocolate  
szary/ grey  
grafitowy/ graphite



## P A T T E R N

ZADRUK NA OPRAWIE NATURA  
TYLKO CZARNYM KOLOREM

PRINTING ON NATURA COVER  
ONLY WITH BLACK COLOUR

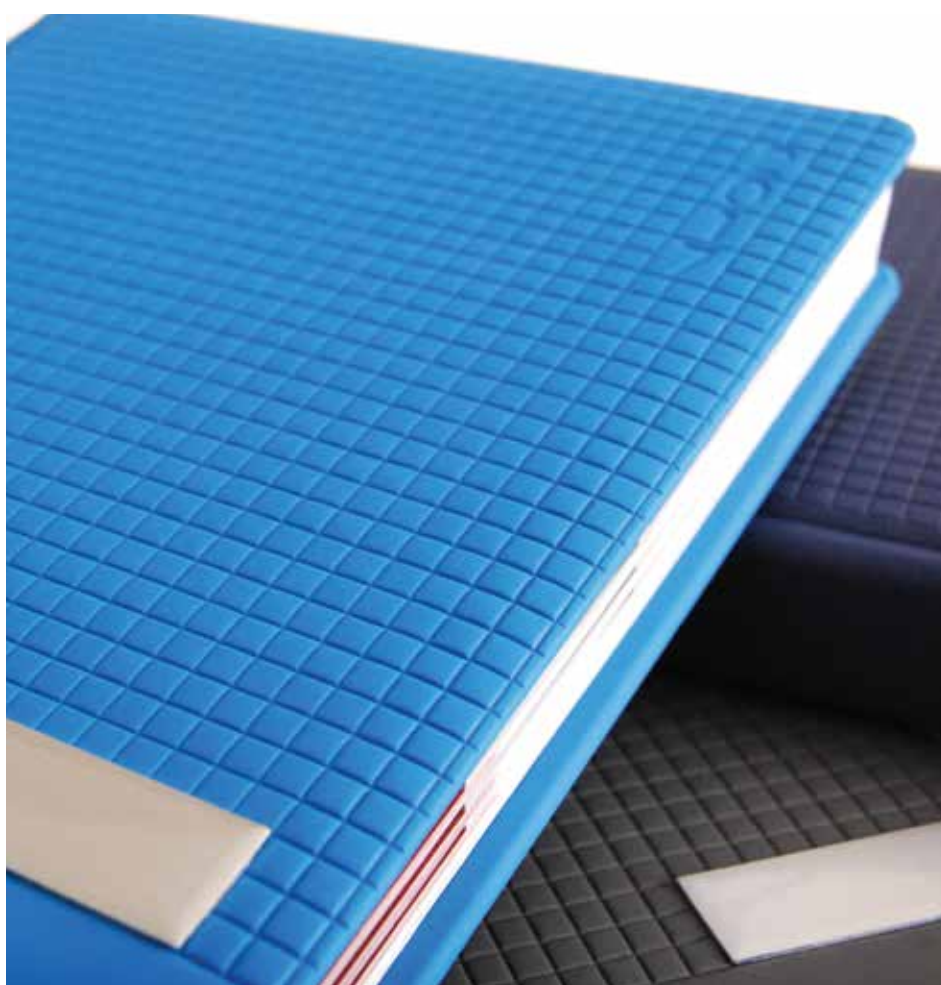

## G U M A

wariant tłoczenia 15  
rok metalowy M3  
gładkie w dotyku  
soft touch

year embossing 15  
metal year M3  
soft in touch

kolorystyka/ colours:

szary/ grey  
czarny/ black  
granatowy/ dark blue  
czerwony/ red  
turkusowy/ turquoise



# G U M A + N D 1 / M 1

new design N1  
element metalowy M1

new design N1  
metal element M1



kolorystyka/ colours:

W Ł Ó K N I N A

czarny/ black  
granatowy/ dark blue

T I T O

czarny/ black  
granatowy/ dark blue

## WŁÓKNINA

wariant tłoczenia 16  
o strukturze gładkiego  
materiału z elementami  
włókien

year embossing 16  
soft texture with fiber

## T I T O

wariant tłoczenia 1  
struktura gładka  
z lekkim przeżyłowaniem

year embossing 1  
smooth structure with veins



# TAILOR

WŁÓKNINA + TITO  
przeszycie oprawy  
rok metalowy M3

cover sewing  
metal year M3





istnieje możliwość wykonania LOGO w postaci metalowego elementu przyklejanego do oprawy - od 500 szt.  
Your logo may be attached to the cover (from 500 pcs).

Istnieje możliwość wykonania LOGO w postaci metalowego elementu przyklejanego do oprawy - od 500 szt.  
Your logo may be attached to the cover (from 500 pcs).





K O N F I G U R A C J A  
Ł Ą C Z E Ń Z R O D Z I N Y O K L E I N  
**C A R B O N**  
C O N F I G U R A T I O N O F  
L A Y O U T S F R O M  
C A R B O N C O V E R F A M I L Y

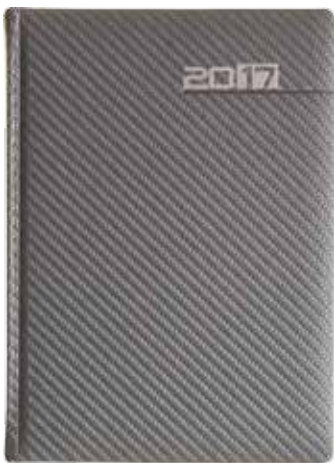

Kalendarz z rodziny **PRESTO** zdobył **NAGRODĘ PUBLICZNOŚCI** w konkursie ZoomART 2016.

Calendar from the **PRESTO** family get an **AUDIENCE AWARD** in ZoomART 2016 competition.

## C A R B O N

rok metalowy M3  
struktura 3D włókna  
węglowego

metal year M3  
3D structure of carbon fibre

kolorystyka/ colours:

granatowy/ dark blue  
grafitowy/ graphite  
czarny/ black

## P R E S T O

C A R B O N + **VIVELA**  
dodatek metalowy M2/M3

metal element M2/M3



---

# L A T T A

CARBON + VIVELA  
blaszka metalowa M2

metal element M2

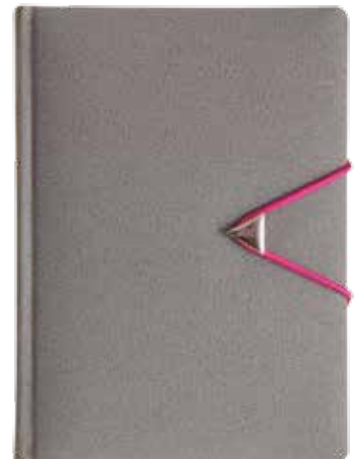
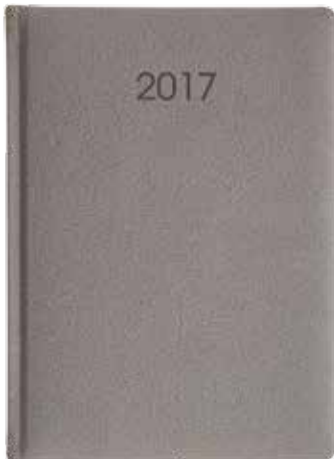

## B E T O N

wariant tłoczenia 1  
o strukturze tynku 3D  
efektowna i designerska

year embossing 1  
3D structure of plaster  
attractive with modern look

kolorystyka/ colours:

szary/ grey

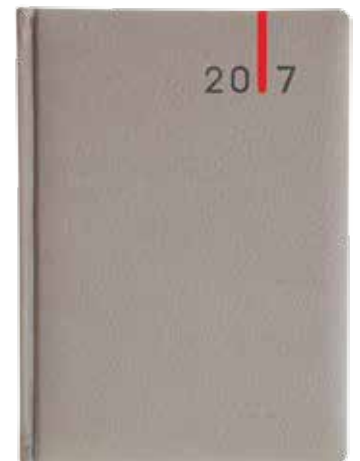
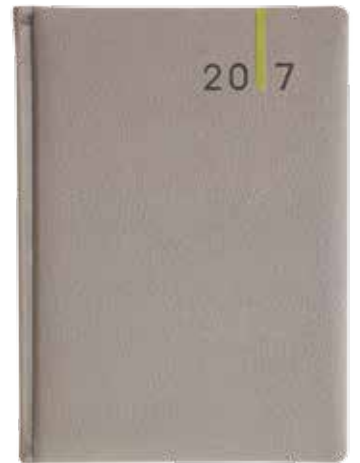
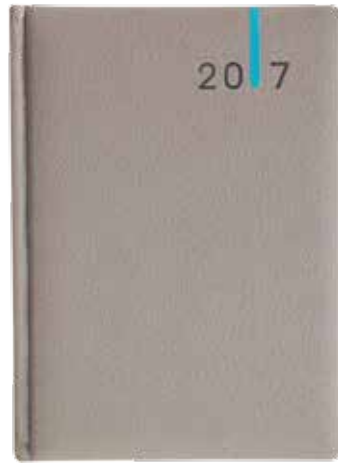
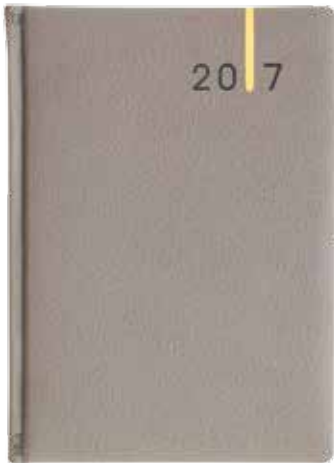

# CEMENTO

BETON + VIVELA  
wariant tłoczenia 10

year embossing 10

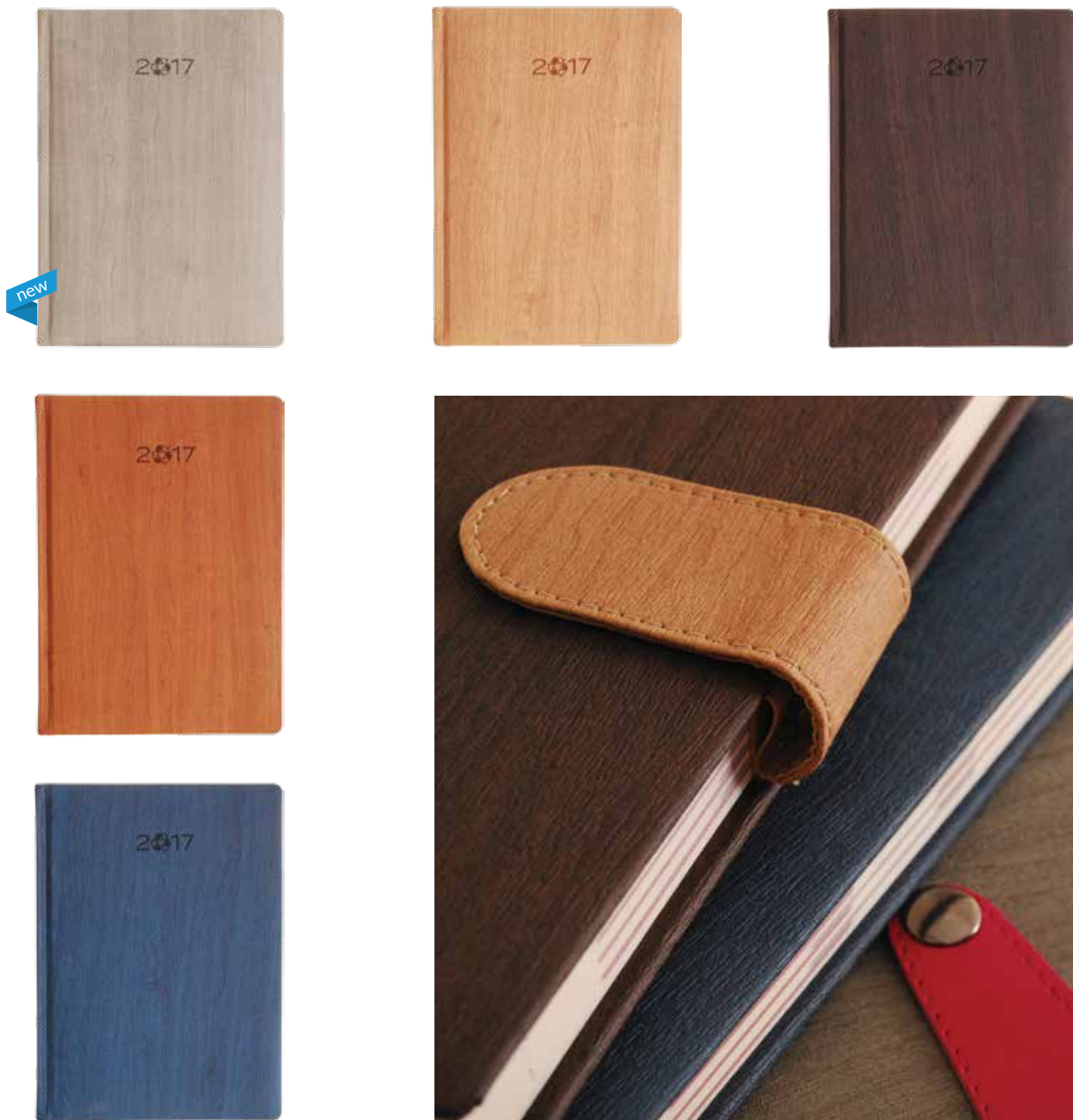

## B O S C O

wariant tłoczenia 3  
o strukturze drewna  
ekskluzywna i designerska

year embossing 3  
wood structure  
modern and exclusive

kolorystyka/ colours:

olcha/ alder  
grusza/ peak bark  
szary/ grey  
wenge/ wenge  
granatowy/ dark blue



# D R V O

BOSCO + BOSCO  
+ CZARNA/BLACK VIVELA  
wariant tłoczenia 16

year embossing 16



TOSKANIA  
GRANATOWY/ DARK BLUE  
VIVELA  
BRĄZOW/ BROWN



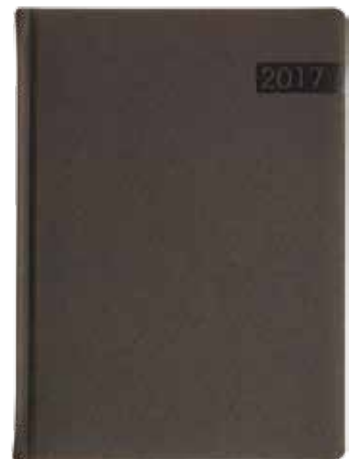

## TOSKANIA

wariant tłoczenia 7  
o strukturze materiał-jeans

year embossing 7  
jeans like structure

kolorystyka/ colours:  
granatowy/ dark blue  
szary/ grey  
grafitowy/ graphite



## V I V E L A

wariant tłoczenia 14  
delikatna, gładka oprawa,  
z lekkim cieniowaniem,  
przyjemna w dotyku

year embossing 14  
delicate smooth cover  
with a little shading  
nice in touch



kolorystyka/ colours:

żółty/ yellow  
 pomarańczowy/ orange  
 czerwony/ red  
 bordowy/ maroon  
 magenta/ magenta  
 fioletowy/ violet  
 turkusowy/ turquoise  
 niebieski/ blue

granatowy/ dark blue  
 ciemny granat/ night blue  
 seledynowy/ willow-green  
 zielony/ green  
 beżowy/ beige  
 brązowy/ brown  
 szary/ grey  
 czarny/ black



# CENTRO

VIVELA + VIVELA  
 wariant tłoczenia 20  
 year embossing 20

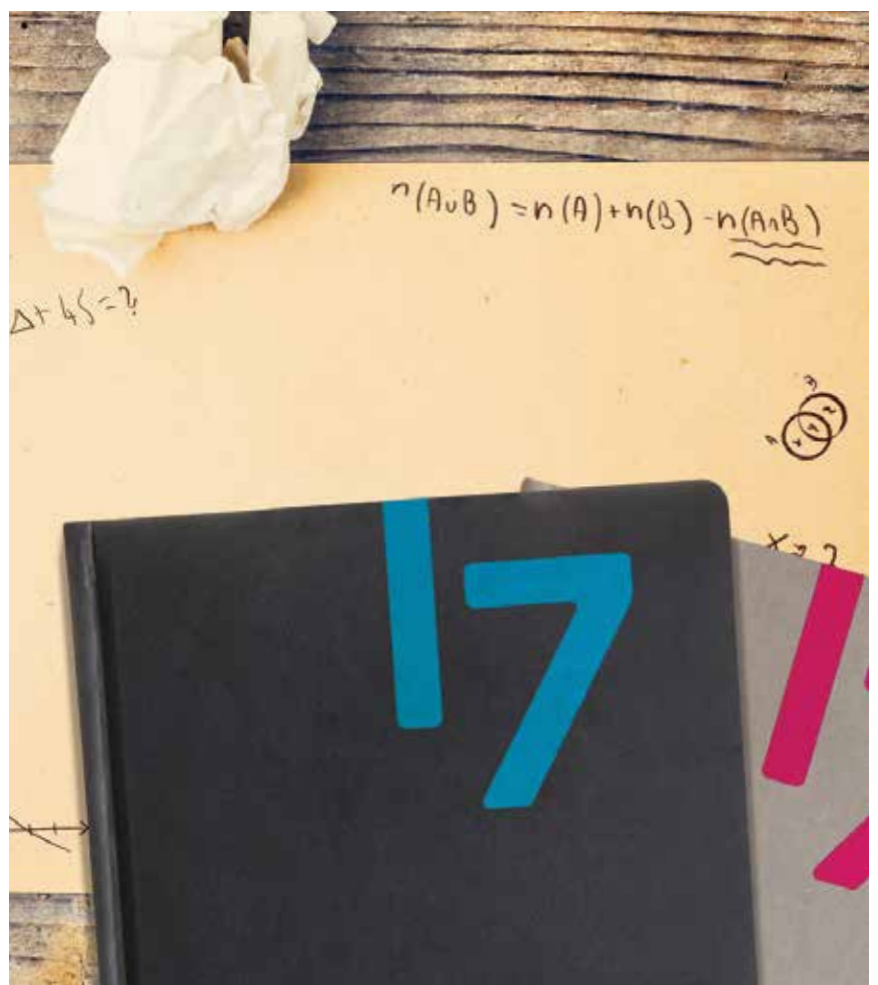

NOVERO

VIVELA + VIVELA

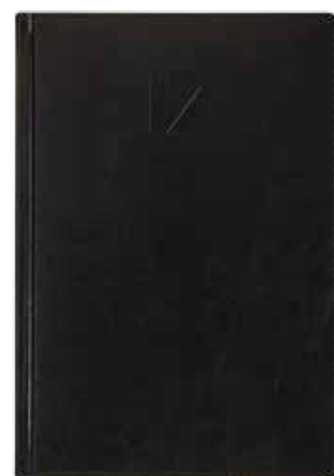
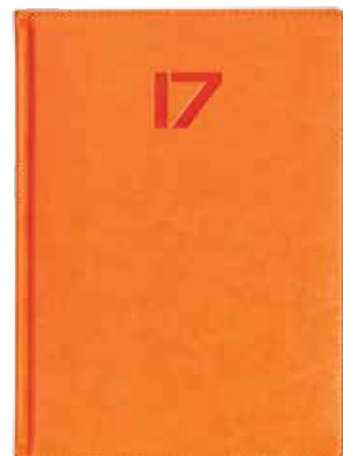

## UV READY

D R U K U V N A  
B I A Ł Y M M A T E R I A L E  
U V P R I N T O N  
W H I T E C O V E R

## I M A G E

obszycie oprawy  
wariant tłoczenia 8  
gładka, połyskująca  
oprawa, ze strukturą  
lekkiego przeżyłowania

cover sewing  
year embossing 8  
smooth, shimmering cover  
with veins

kolorystyka/colours:

szary/ grey  
grafitowy/ graphite  
czarny/ black  
biały/ white  
granatowy/ dark blue  
fioletowy/ violet  
seledynowy/ willow-green  
zielony/ green



---

pomarańczowy/ orange  
czerwony/ red  
czekoladowy/chocolate  
cieniowana cegła/ gradient brick  
bordowy/ maroon  
brązowy/ brown



# T A S S O

IMAGE + IMAGE  
wariant tłoczenia 4

year embossing 4



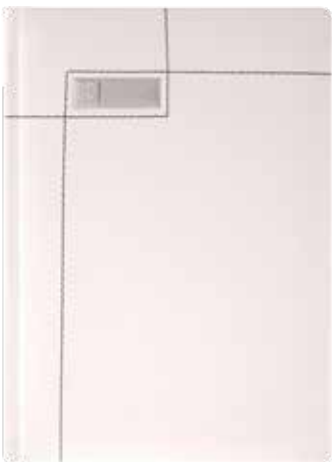
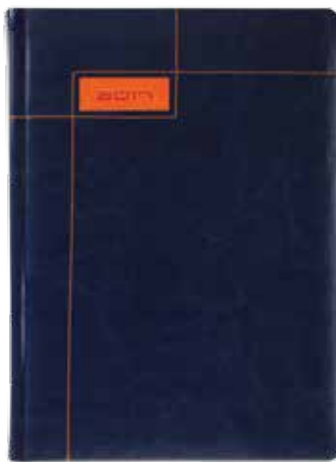

## RETTO + M2

IMAGE + IMAGE  
element metalowy M2

metal element M2

## R E T T O

IMAGE + IMAGE  
wariant tłoczenia 5

year embossing 5



## CROSS + M5

wariant tłoczenia 17  
kryształek M5

year embossing 17  
cristal M5

kolorystyka/ colours:

turkusowy/ turquoise  
malinowy/ raspberry  
pomarańczowy/ orange  
czerwony/ red  
miedziany/ cooper  
czekoladowy/ chocolate

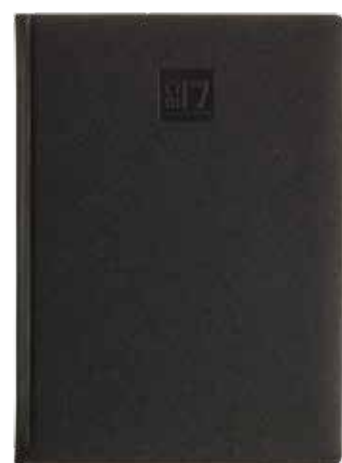
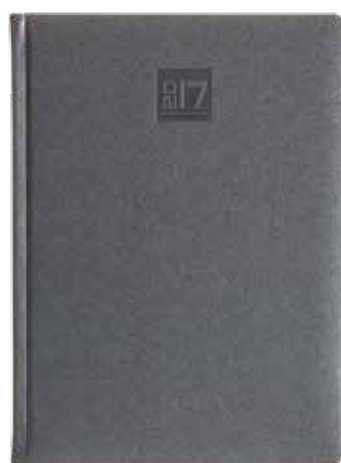
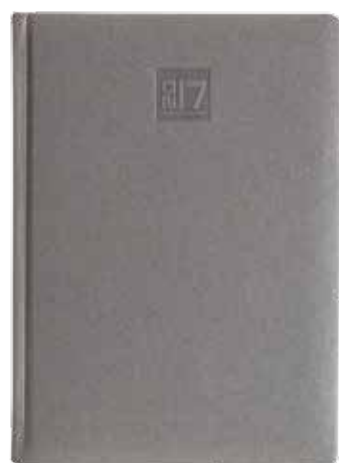
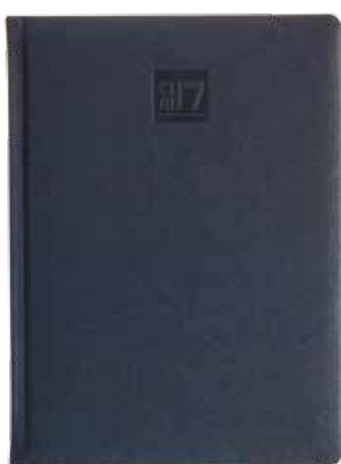
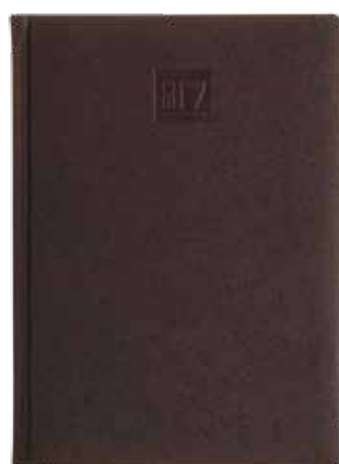

---

granatowy/ dark blue  
zielony/ green  
szary/ grey  
grafitowy/ graphite  
czarny/ black

## C R O S S

wariant tłoczenia 6  
o strukturze  
nieregularnego płótna

year embossing 6  
irregular structure of canvas

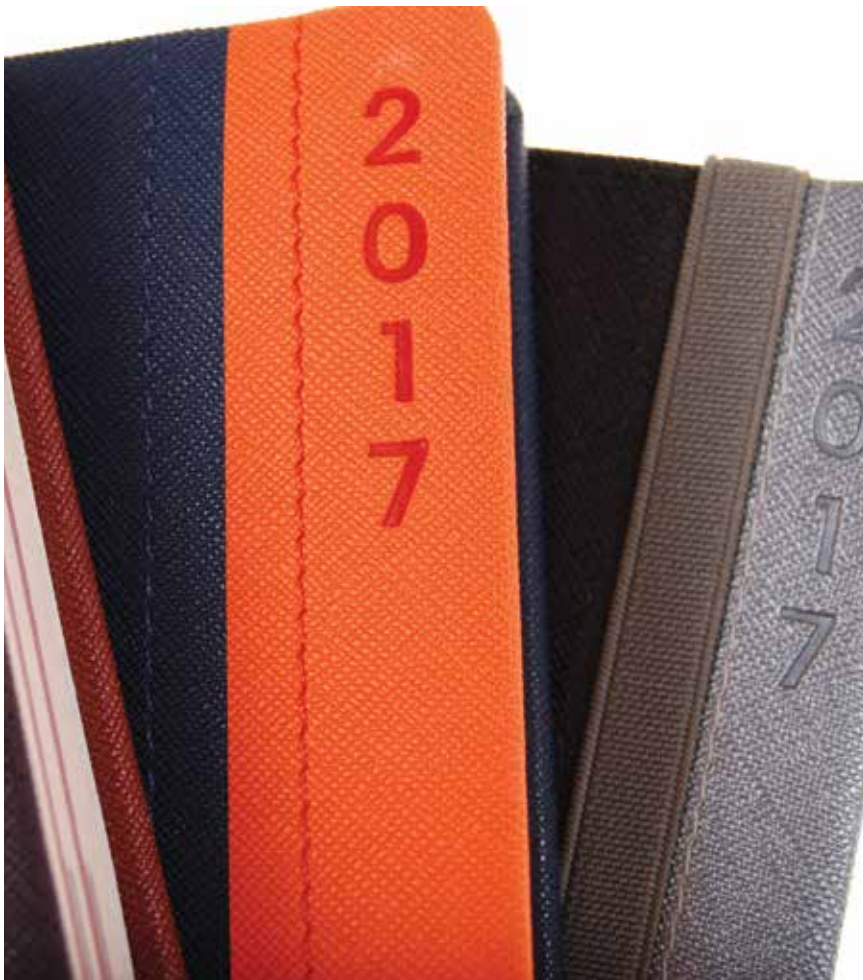

# T W I N

CROSS + CROSS  
 przeszycie oprawy  
 wariant tłoczenia 19  
 gumka 10 mm

cover sewing  
 year embossing 19  
 rubber band 10 mm



# LINEA

CROSS + CROSS + CROSS  
rok metalowy M3

metal year M3

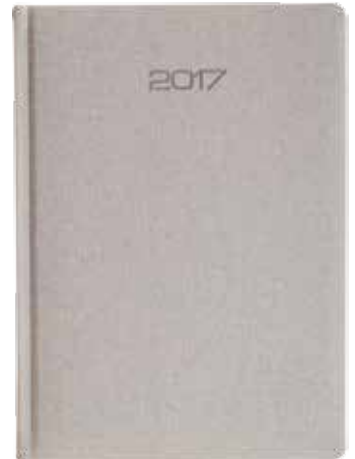
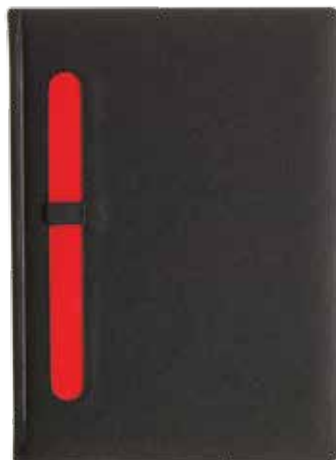
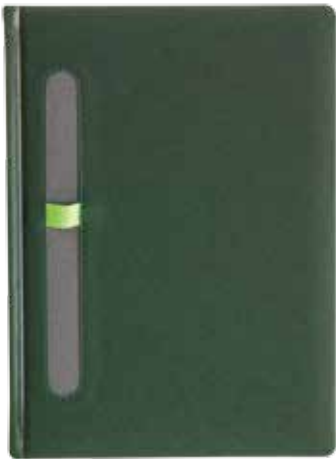

## P E N N A

CROSS + CROSS  
przeszycie oprawy  
wariant tłoczenia 19  
gumka 10 mm

cover sewing  
year embossing 19  
rubber band 10 mm

## J U T A

wariant tłoczenia 2  
matowa oprawa  
o strukturze tkanego płótna

year embossing 2  
matt cover with canvas  
structure

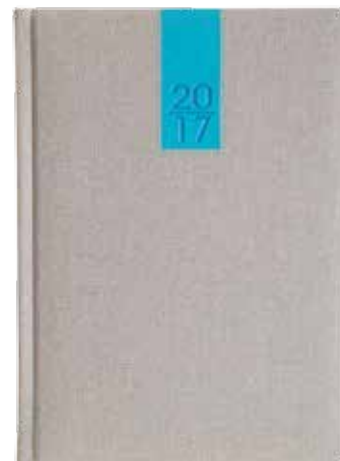
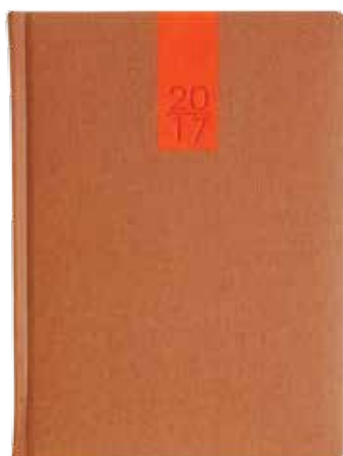
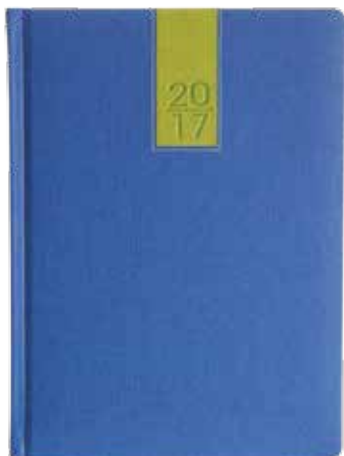

kolorystyka/ colours:

granatowy/ dark blue

brązowy/ brown

szary /grey

L I M O

J U T A + V I V E L A

obszycie wstawki

wariant tłoczenia 9

insert sewing

year embossing 9



## UV READY

druk UV na  
białym materiale  
UV print on  
white cover

## I D E O

wariant tłoczenia 16  
rok metalowy M3  
o strukturze matowej skóry  
biznesowa i elegancka

year embossing 16  
metal year M3  
matt leather  
structure  
professional and elegant

kolorystyka/ colours:

seledynowy/ willow-green  
czarny/ black  
granatowy/ dark blue  
czerwony/ red  
biały/ white





# D O P I O

I D E O + I D E O  
L U B / O R V I V E L A  
przeszyć oprawy  
wariant tłoczenia 5

cover sewing  
year embossing 5

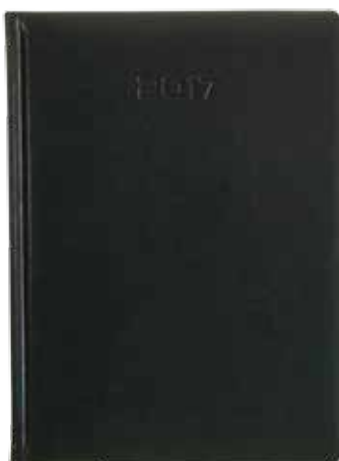
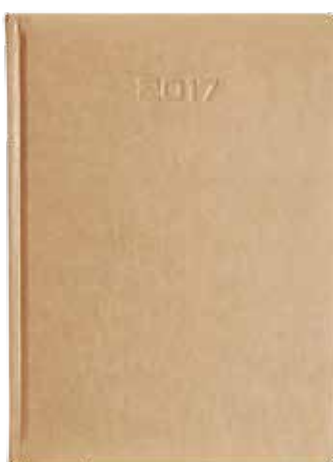
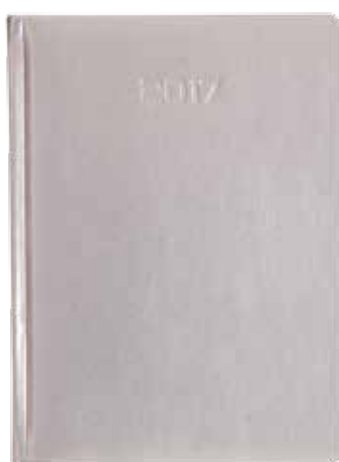
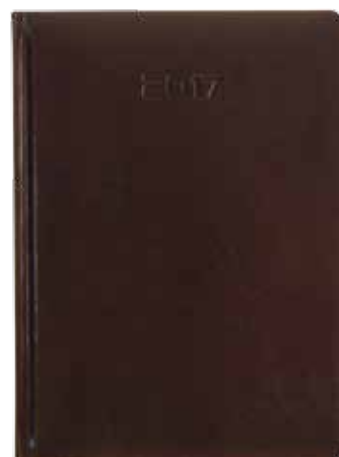
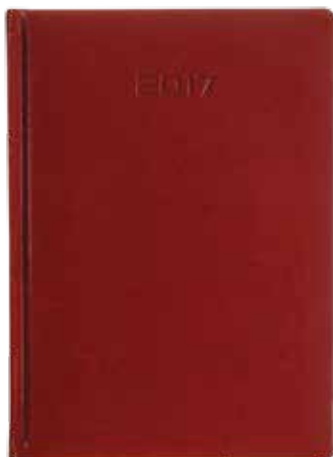

## COLORADO

wariant tłoczenia 4

year embossing 4

kolorystyka/ colours:

czerwony/ red  
bordowy/ maroon  
czekoladowy/ chocolate  
srebrny/ silver  
złoty/ gold  
zielony/ green  
granatowy/ dark blue  
szary/ grey  
grafitowy/ graphite  
czarny/ black

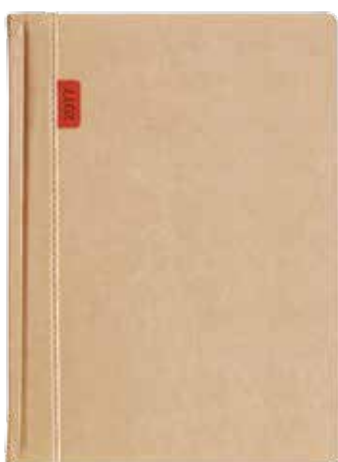
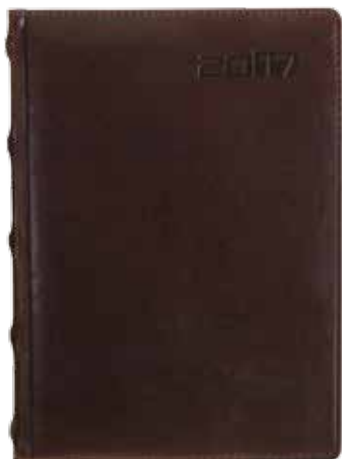

COLORADO  
RUSTYKALNE

wariant tłoczenia 19  
garbik na grzbiecie

year embossing 19

P E Z Z O

COLORADO + VIVELA  
przeszyte oprawy  
wariant tłoczenia 5

cover sewing  
year embossing 17



# F I L C

FILC + VIVELA  
 obszycie oprawy  
 wariant tłoczenia 1  
 wymienny blok

year embossing 1  
 cover sewing  
 replaceable block

kolorystyka/ colours:

szary/ grey



biała papierowa okładka  
pokryta folią błysk w zestawie

white paper cover  
with gloss foil included

cover sewing  
year embossing 1C  
rubber band 10 mm  
replecable block

INSERTO

FILC + VIVELA  
obszycie oprawy  
warant tłoczenia 1C  
gumka 10 mm  
wymienny blok



## ITALIANO

przeszycie i obszycie  
oprawy  
rok metalowy M3

SKÓRA NATURALNA  
z lekkim połyskiem

cover sewing  
metal year M3

NATURAL LEATHER  
with gloss effect

kolorystyka/ colours:

zielony/ green  
czarny/ black  
szary/ grey  
czerwony/ red  
bordowy/ maroon  
brązowy/ brown  
granatowy/ dark blue



zapięcie na zamek /claps closure

zapięcie na magnes /magnetic closure

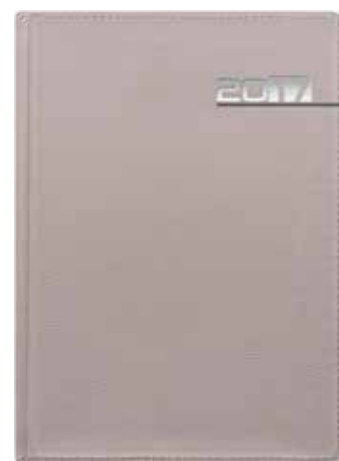

# BIZNES PLUS

zapięcie wymienny blok

closure replecable block

# CORRIDA

rok metalowy M3  
obszycie oprawy

metal year M3  
cover sewing

kolorystyka/ colours:

granatowy/ dark blue  
czarny/ black  
szary/ grey



WYPRZEDAŻ  
**SALE%**

DO WYCZERPANIA ZAPASÓW  
MAGAZYNOWYCH  
till the supply lasts

**S U D A N**

wariant tłoczenia 4  
year embossing 4

kolorystyka/ colours:

bordowy/ maroon  
brązowy/ brown  
czekoladowy/ chocolate  
granatowy/ dark blue





sale%



sale%



sale%



sale%



sale%



sale%



sale%



sale%



sale%

## MADERA

wariant tłoczenia 11  
obszycie oprawy  
year embossing 11  
cover sewing  
kolorystyka/ colours:

zielony/ green  
bordowy/ maroon  
granatowy/ dark blue

## PELLE

wariant tłoczenia 8  
year embossing 8

kolorystyka/ colours:

brązowy/ brown  
oliwkowy /olive  
beżowy/ beige

## VERONA

wariant tłoczenia 5  
year embossing 5

kolorystyka/colours:

seledynowy/ willow-green  
żółty/ yellow  
czerwony/ red





**N O T E S Y**  
**NOTEBOOKS**  
DODATEK/ ADD M6/M7  
GUMKA/RUBBER 10MM



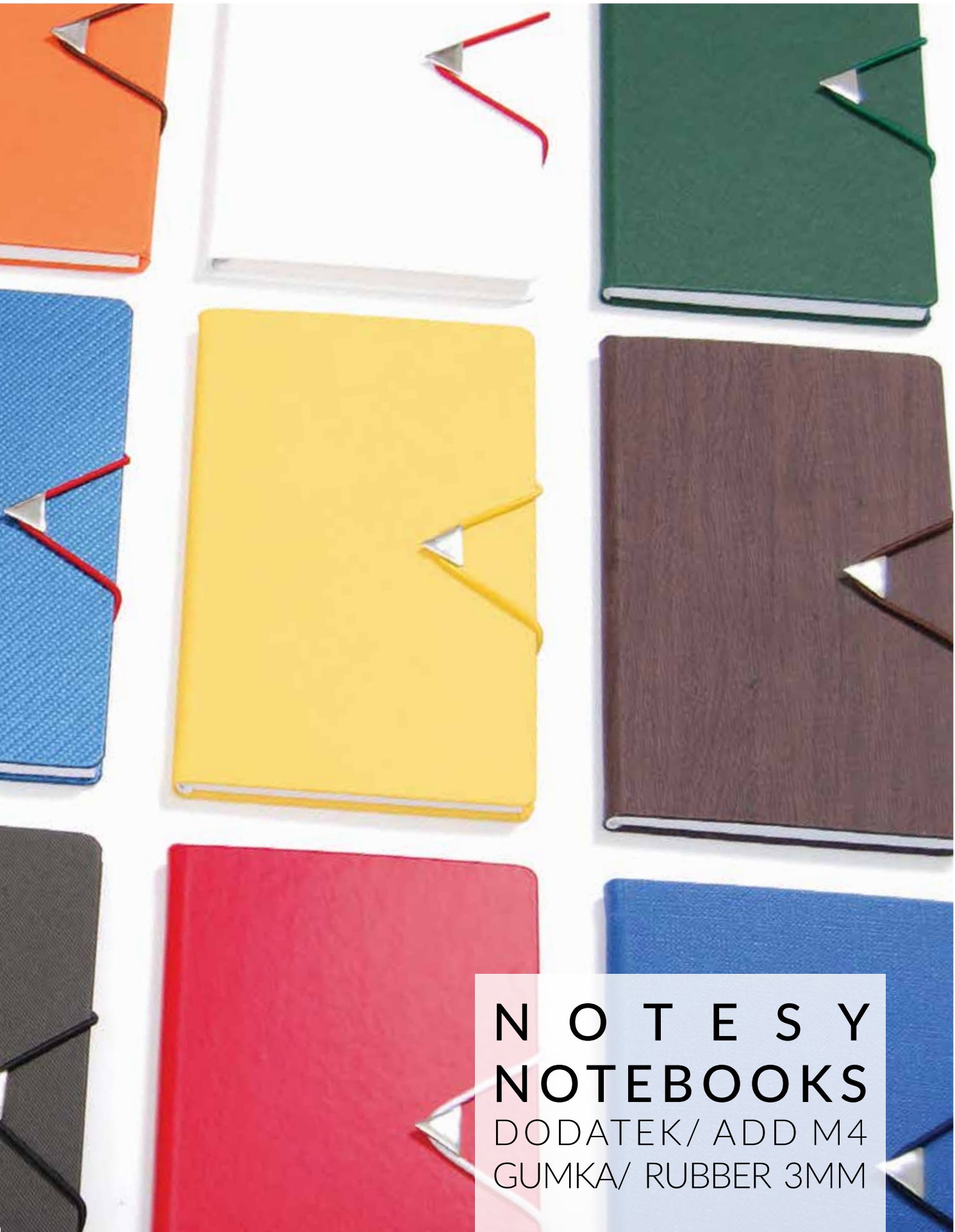

**N O T E S Y**  
**NOTEBOOKS**  
DODATEK/ ADD M4  
GUMKA/ RUBBER 3MM

MINISTRA BLACK

PIÓRO + DŁUGOPIS/  
PEN + BALLPOINT PEN



PEN INFO
COLOR/COLOUR: czarny/czerwony black/red
MATERIAŁ/MATERIAL: metal/metal
ZNAKOWANI /MARKING: laser 4 mm x 45 mm
DODATKI/ADDITIONAL INFO: niebieski wkład/blue refill

MINISTRA RED

PIÓRO + DŁUGOPIS/  
PEN + BALLPOINT PEN



CUT SILVER

PIÓRO/PEN



PEN INFO
COLOR/COLOUR: czarny/black
MATERIAŁ/MATERIAL: metal/ metal
ZNAKOWANIE/MARKING: laser 4 mm x 45 mm
DODATKI/ADDITIONAL INFO: niebieski wkład/blue refill

CUT ROSE GOLD

PIÓRO + DŁUGOPIS/  
PEN + BALLPOINT PEN



## LIGHT BLACK

PIÓRO + DŁUGOPIS/  
PEN + BALLPOINT PEN



PEN INFO
COLOR/COLOUR: czarny/czerwony black/red
MATERIAŁ/MATERIAL: metal/metal
ZNAKOWANIE/MARKING: laser 4 mm x 45 mm
DODATKI/ADDITIONAL INFO: niebieski wkład/blue refill

## LIGHT RED

PIÓRO + DŁUGOPIS/  
PEN + BALLPOINT PEN



PEN INFO
COLOR/COLOUR: czarny/black
MATERIAŁ/MATERIAL: metal/metal
ZNAKOWANIE / MARKING: laser 4 mm x 45 mm
DODATKI/ADDITIONAL INFO: niebieski wkład/blue refill touch pen

## TOUCH

DŁUGOPIS / BALLPOINT PEN



## CRISTALLO

DŁUGOPIS/BALLPOINT PEN



PEN INFO
COLOR/COLOUR: czarny/black
MATERIAŁ/MATERIAL: metal/metal
ZNAKOWANIE/MARKING: laser 4 mm x 45 mm
DODATKI/ADDITIONAL INFO: niebieski wkład/blue refill kryształek Swarovskiego/Swarovski crystal

## FASHION WHITE

DŁUGOPIS/BALLPOINT PEN



PEN INFO
COLOR /COLOUR: biały/srebrny white /silver
MATERIAŁ/MATERIAL: metal / metal
ZNAKOWANIE/MARKING: laser 4 mm x 45 mm
DODATKI/ADDITIONAL INFO: niebieski wkład/blue refill kryształek Swarovskiego/Swarovski crystal

## FASHION SILVER

DŁUGOPIS/BALLPOINT PEN





MDF/ MDF





BIAŁY / WHITE

CZARNY / BLACK



## LEGENDA

- 01 WYKLEJKA/ ENDPAPER
- 02 WKLEJKA/ INSERT PAGES
- 03 BLOK AUTORSKI/ INDIVIDUAL PRINTING
- 04 DRUK UV NA BIAŁEJ OPRAWIE/ UV PRINTING ON WHITE COVER
- 05 TASIEMKA SUBLIMACYJNA/ INDIVIDUAL SUBLIMATION RUBBER
- 06 OPRAWA DRUKOWANA Z FOLIA MATOWA/  
HARD COVER FULL COLOUR AND MATT FOIL
- 07 DŁUGOPIS CALIPSO Z GRAWEREM / CALIPSO PEN WITH ENGRAVING
- 08 TŁOCZENIE SPADOWE/ DEEP EMBOSING
- 09 KOPERTA Z NADRUKIEM/ POCKET WITH FULL COLOUR PRINT



02

03

09

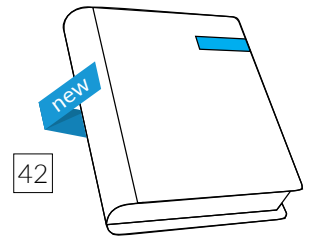
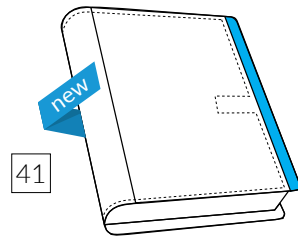
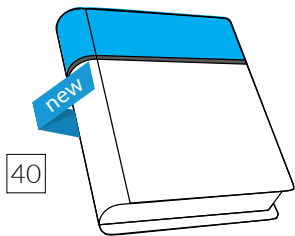
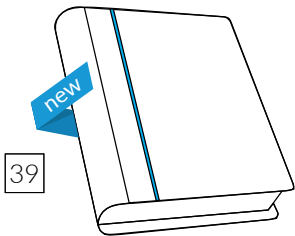
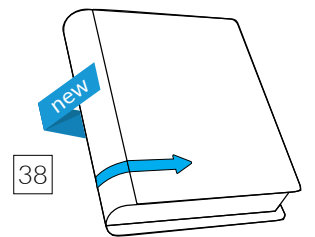
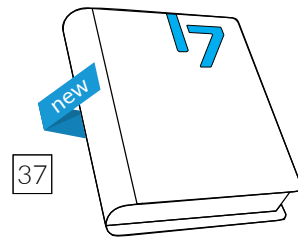
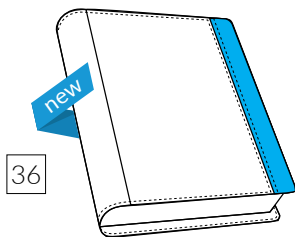
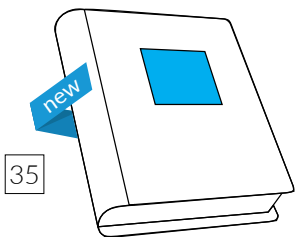
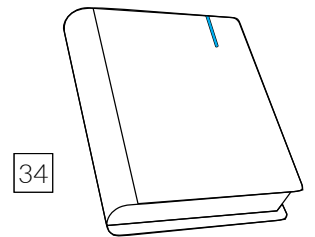
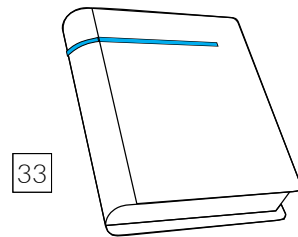
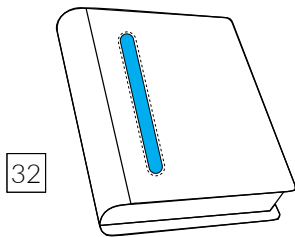
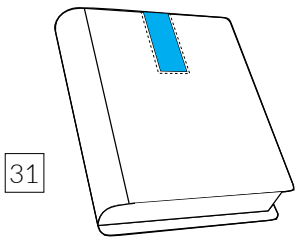
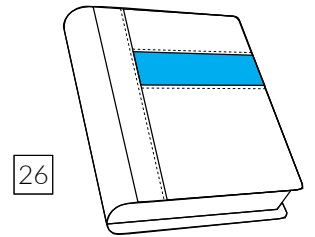
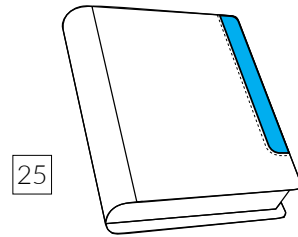
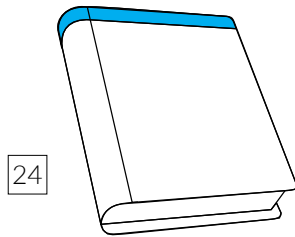
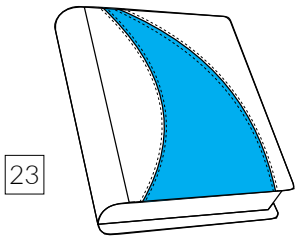
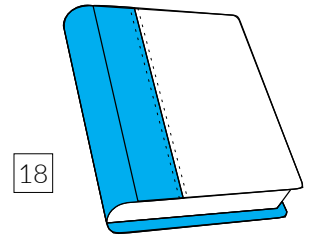
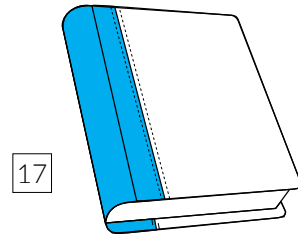
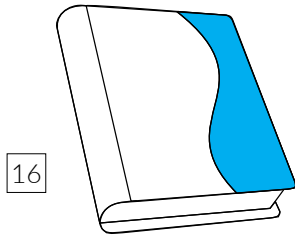
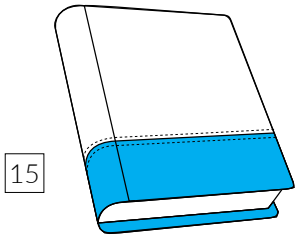
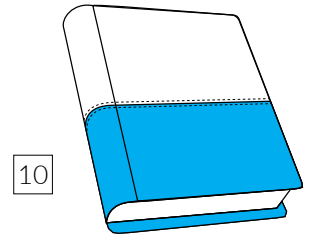
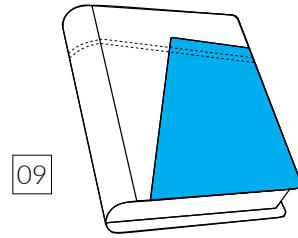
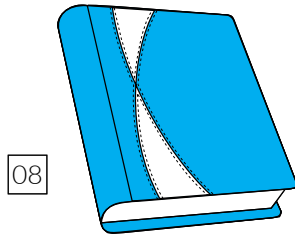
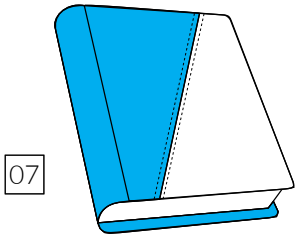
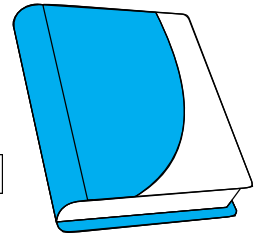
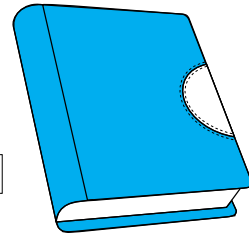

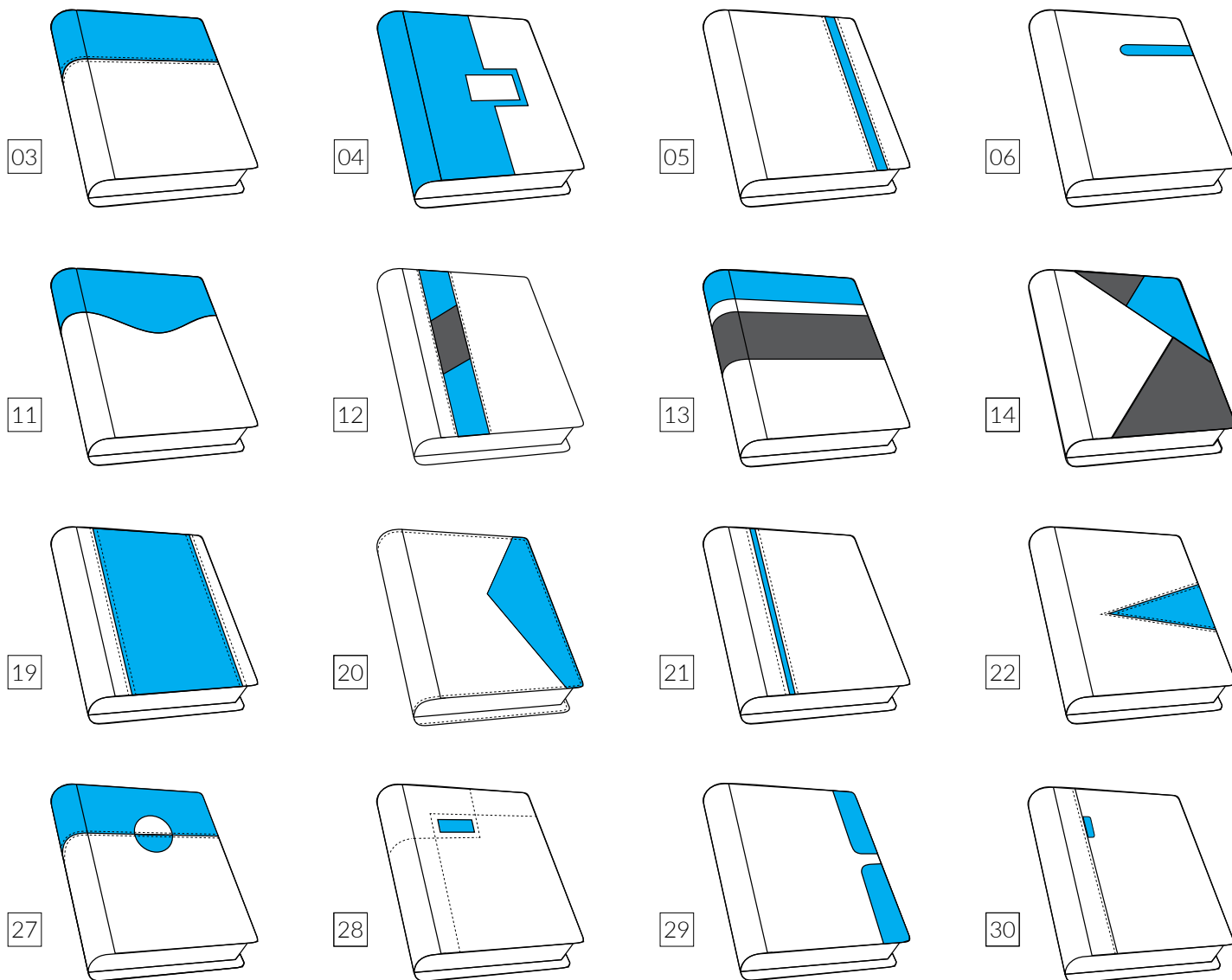

# WYBIERZ DODATKI I SKOMPONUJ SWÓJ KALENDARZ CHOOSE ADDS AND COMPOSE YOUR CALENDAR



M3 ROK METALOWY PRZYKLEJANY DO OPRAWY/  
METAL YEAR GLUE TO COVER

ROZMIAR/SIZE: 43 mm x 11 mm



M4 METALOWY TRÓJKĄT (SREBRNY) MOCOWANY  
NA NIT/SILVER TRIANGLE METAL ELEMENT WITH  
RIVETS

POLE GRAWERU/ENGRAVERING AREA: 11 mm x 4 mm



M7 BLASZKA PROSTOKĄTNA (SREBRNA/GRAFITOWA)  
MOCOWANA NA GUMCE 10 MM/RECTANGLE  
(SILVER/GRAPHITE) METAL ELEMENT ON 10 mm  
RUBBER TAB

POLE GRAWERU/ENGRAVERING AREA: 28 mm x 8 mm



M8 PENDRIVE 8 GB MOCOWANY W OPRAWIE/PEN-  
DRIVE 8 GB

ROZMIAR /SIZE: 34 mm x 11 mm  
POLE GRAWERU/ENGRAVERING AREA: 28 mm x 8 mm

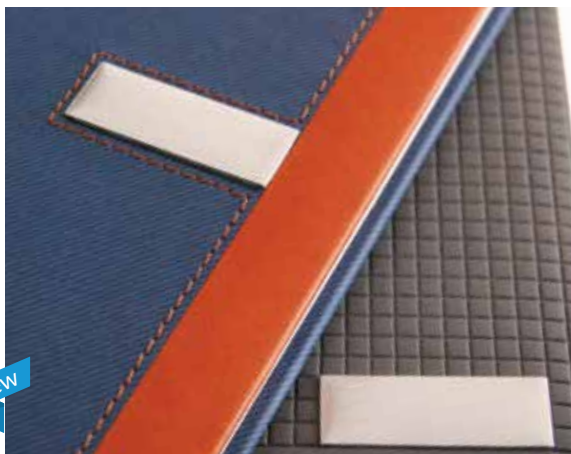

M1

SZCZOTKOWANA ALUMINIOWA BLASZKA  
(SREBRNA) POD GRAWER/ METALPLATE  
RECTANGLE ELEMENT FOR ENGRAVERING  
ROZMIAR/SIZE: 40 mm x 14 mm  
POLE GRAWERU/ENGRAVERING AREA: 12 mm x 26 mm



M2

SZCZOTKOWANA ALUMINIOWA BLASZKA  
(SREBRNA) POD GRAWER Z TŁOCZONYM ROKIEM/  
METALPLATE ( SILVER) FOR ENGRAVERING WITH THE  
YEAR ON THE CONTEX  
ROZMIAR/SIZE: 40 mm x 14 mm  
POLE GRAWERU/ENGRAVERING AREA: 12 mm x 38 mm



M5

KRYSTAŁEK PRZYKLEJANY DO OPRAWY /  
CRISTAL GLUE TO COVER

ROZMIAR/SIZE 10 mm x 10 mm



M6

BLASZKA KWADRATOWA (SREBRNA/GRAFITOWA)  
MOCOWANA NA GUMCE 10 mm/SQUARE (SILVER/  
GRAPHITE) METAL ELEMENT ON 10 mm RUBBER TAB

POLE GRAWERU/ENGRAVERING AREA: 23 mm x 13 mm



M9

ZAPIĘCIE (ZAWIJAS) Z MIEJSCEM NA DŁUGOPIS/  
LEATHER TAB WITH PEN HOLDER

POLE GRAWERU/ENGRAVERING AREA: 8 mm x 8 mm



M10

PATKA ZAMYKANA NA MAGNEZ Z MIEJSCEM NA  
DŁUGOPIS, MAGNEZ UKRYTY W OPRAWIE/  
LEATHER TAB WITH MAGNETIC CLOSURE AND  
PEN HOLDER

biały  
whiteszary  
greyczarny  
blackżółty  
yellowpomarańczowy  
orangeczerwony  
redmagenta  
magentaturkusowy  
turquoiseniebieski  
bluegranatowy  
dark blueseledynowy  
willow-greenjasny zielony  
light greenciemny zielony  
dark greenbrązowy  
brown

**GUMKI 10 MM/  
RUBBERS 10 MM**



**TASIEMKI TKANE  
/ SUBLIMACYJNE  
RIBBONS  
WOVEN / SUBLIMATION**

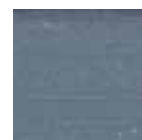
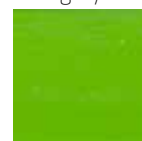
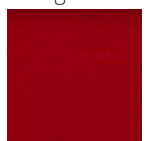
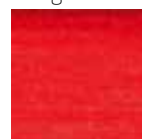
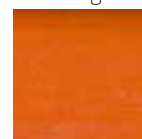

**KOLOROWE BRZEGI  
COLORFULL EDGES**

czarny  
blackszary  
greysrebrny  
silverzłoty  
goldzielony  
greenseledynowy  
willow-greenróżowy  
pinkbordowy  
maroonczerwony  
redpomarańczowy  
orangeżółty  
yellowgranatowy  
dark blue





## DODATEK/ADD M9

Zapięcie (zawijas) z miejscem na długopis/Leather tab with pen holder



## DODATEK/ADD M10

Patka zamykana na magnes ukryty w oprawie z miejscem na długopis  
Leather tab with magnetic closure and pen holder



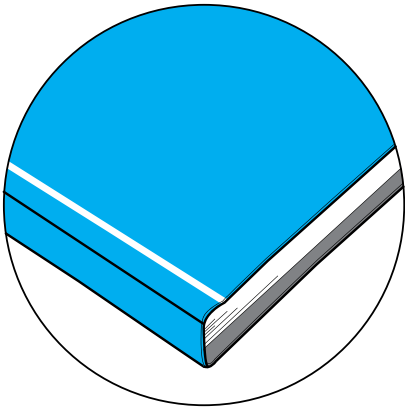

OPRAWA STANDARDOWA: TEKSTURA ZPIANKĄ I  
BIGIEM/STANDARD COVER WITH BEND

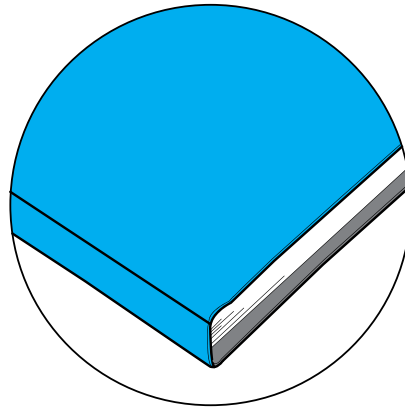

OPRAWA TWARDA: Z TEKSTURĄ BEZ BIGU/  
HARD COVER WITHOUT BEND

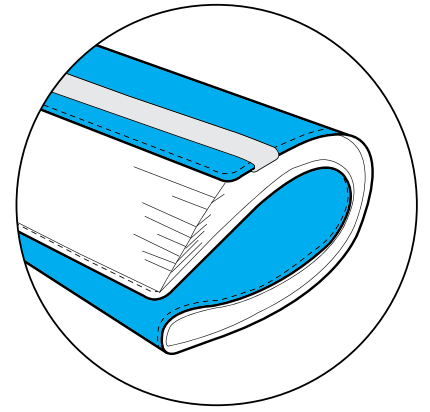

OKŁADKA FLEXI/  
FLEXI COVER

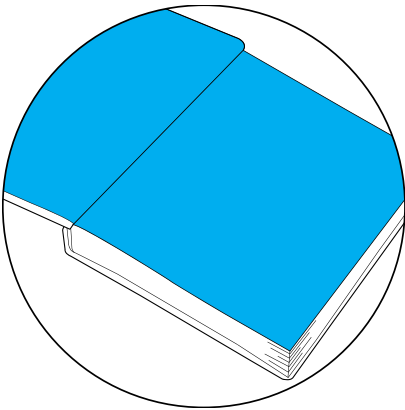

WYKLEJKA/  
ENDPAPER

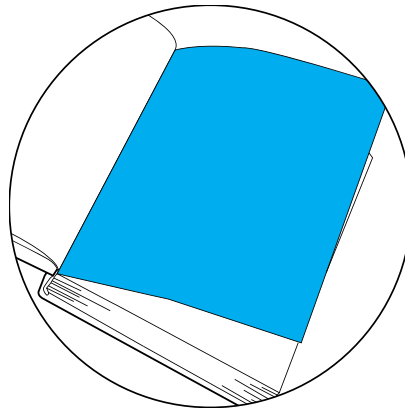

WKLEJKA/  
INSERT SHEET

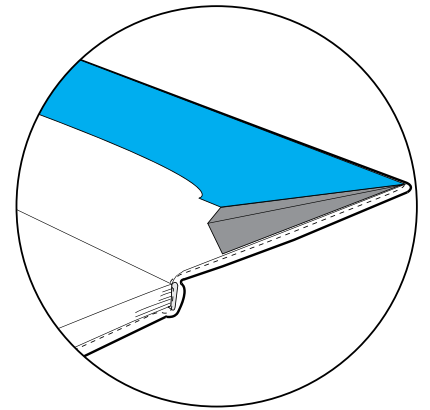

KOPERTA/  
POCKET

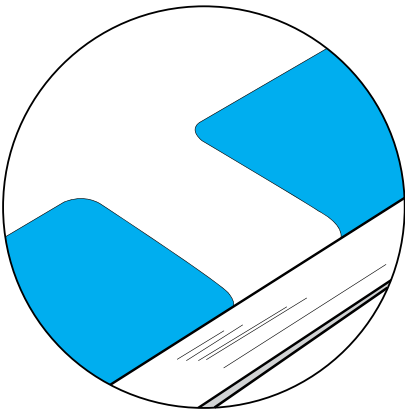

ŁĄCZENIE OPRAW/  
COVER COMBINATION

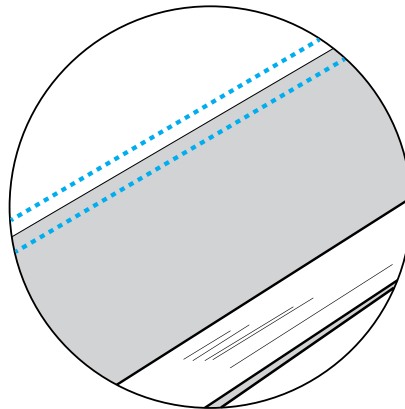

PRZESZYCIE OPRAWY/  
SE WING ???

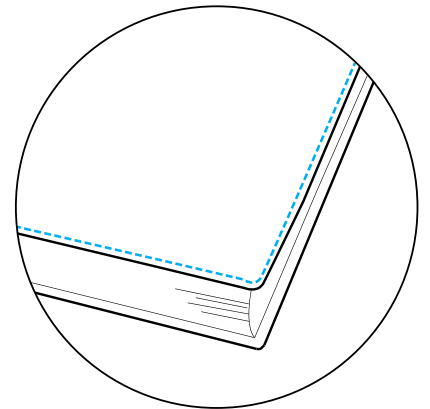

OBSZYCIE OKŁADKI/  
SEWING ???

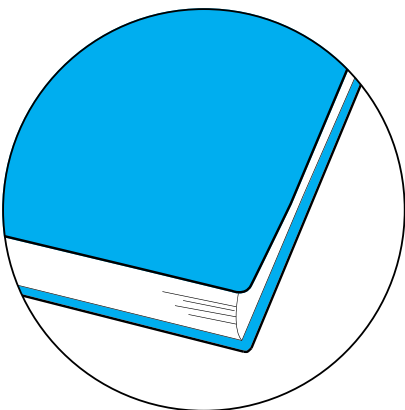

ZAOKRĄGLONE ROGI OKŁADKI/  
ROUND COVER CORNERS

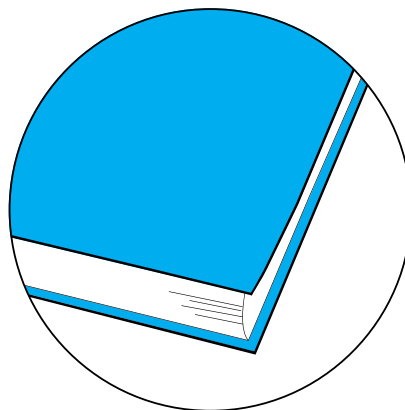

PROSTE ROGI OKŁADKI/  
SQUARE COVER CORNERS

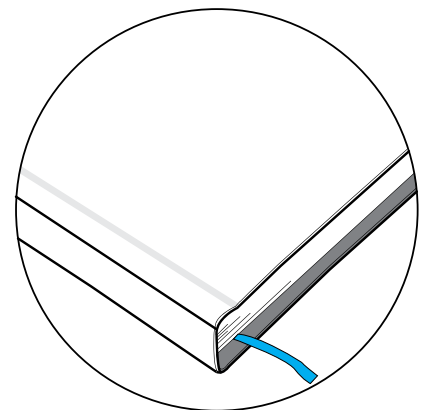

TASIEMKA/  
RIBBON

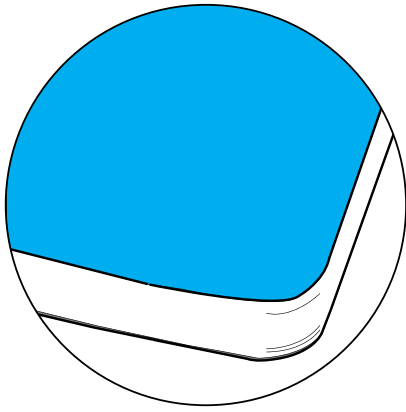

OPRAWA ŚCINANA RÓWNO Z BLOKIEM  
(TYLKO NOTESY)/SOFT COVER  
(ONLY NOTEBOOKS)

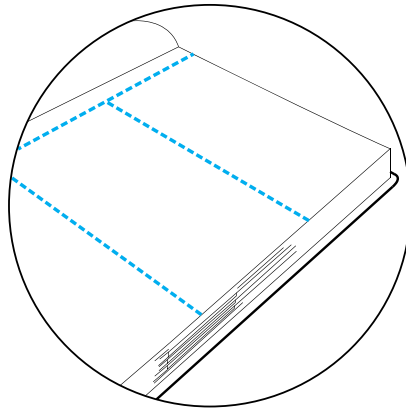

PERFORACJA STRON (TYLKO NOTESY A5,A4)/  
PAGE PERFORATION (ONLY NOTEBOOK A5,A4)

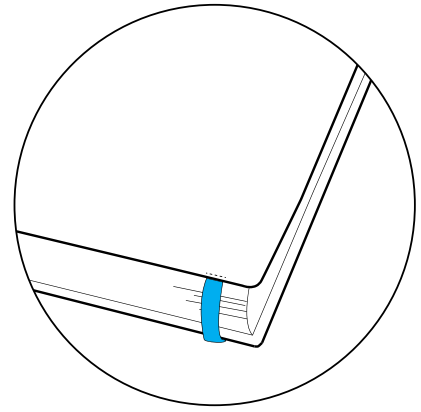

GUMKA PRZYSZYWANA DO OPRAWY  
(STANDARDOWA)/SEWED ELASTIC BAND  
TO COVER (STANDARD)

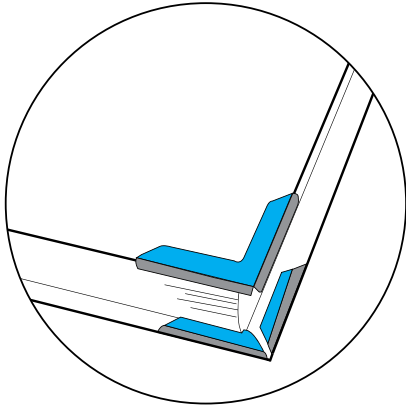

METALOWE NAROŻNIKI/  
METAL COVER CORVER

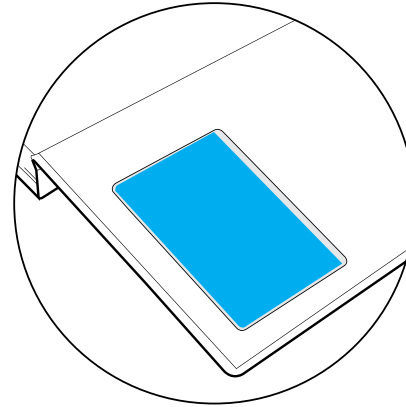

OKIENKO NA WIZYTÓWKĘ/  
RECTANGLE POCKET FOR BUSINESS CARD

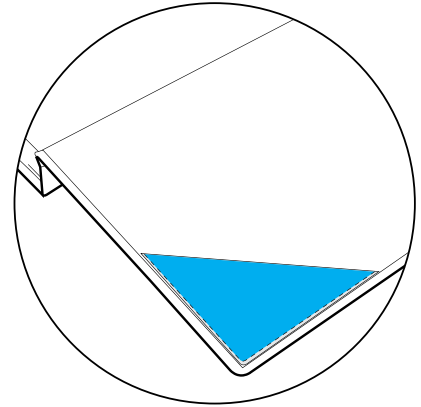

TRÓJKĄTNA KIESZONKA/  
TRANGLE POCKET FOR BUSINESS CARD

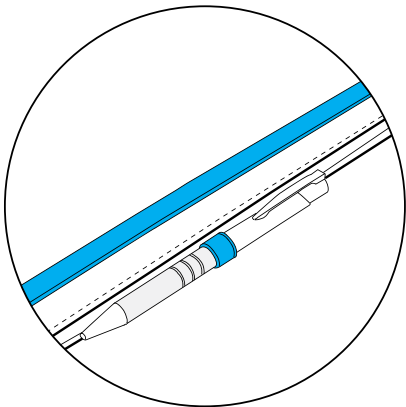

GUMKA I SZLUFKA NA DŁUGOPIS/  
STANDARD ELASTIC BAND + PENHOLDER

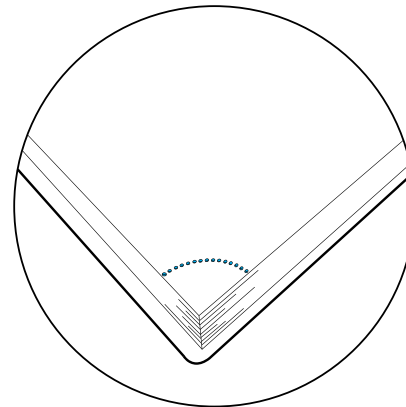

PERFORACJA NAROŻNIKÓW/  
CORNERS PERFORATION

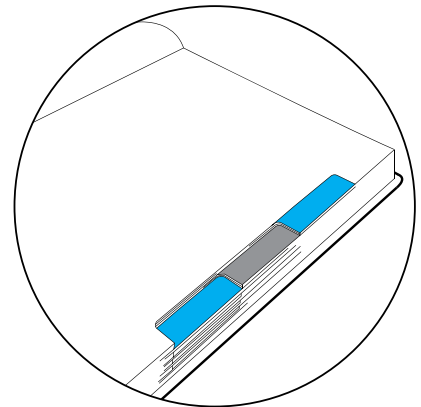

WYCINANE REGISTRY/  
INDEX CUTED

## DODATKI/ADDS

D O S T Ę P N E  
M O Ź L I W O Ś C I  
E N A B L E P O S S I B I L I T I E S

1A 2017

50 x 18 mm

1B 2017

50 x 18 mm

1C 2017

25 x 9 mm

2A 2017

50 x 13 mm

2A 2017

35 x 9 mm

2C 2017

25 x 6 mm

3A 2017

50 x 17 mm

3B 2017

35 x 12 mm

3C 2017

25 x 8 mm

4A 2017

50 x 14 mm

4B 2017

35 x 10 mm

4C 2017

25 x 7 mm

5A 2017

50 x 8 mm

5B 2017

35 x 6 mm

5C 2017

25 x 4 mm

6 2017

24 x 24 mm

7 2017

42 x 14 mm

krawędź oprawy/cover edge

8 17

30 x 25 mm

9 20/17

20 x 25 mm

10 2017

40 x 12 mm

krawędź oprawy/cover edge

łata/patch 3 x 23 mm

rok 10 z zestawie z przeszyciem 34/  
year 10 only with cover layout 34

11 2017

17 x 32 mm

krawędź oprawy/cover edge



M1

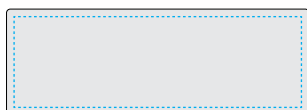

blaszka metalowa/metal element 40 x 14 mm  
pole graweru/engraving area: 38 x 12 mm

M2



blaszka metalowa/metal element 40 x 14 mm  
pole graweru/engraving area: 12 x 26 mm

M3



rok metalowy / metal element 43 x 11 mm

M4

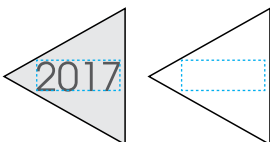

16 x 18 mm

pole graweru/engraving area: 11 x 4 mm

M9

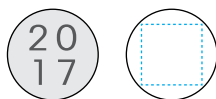

12 x 12 mm

pole graweru/engraving area: 8 x 8 mm

12

2017

15 x 2 mm

13

2017

14 x 5 mm

krawędź oprawy/cover edge

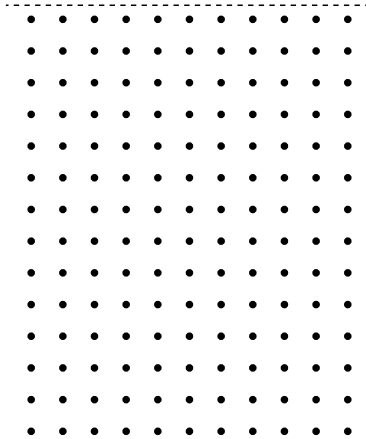

14

2017

43 x 69 mm

krawędź oprawy/cover edge

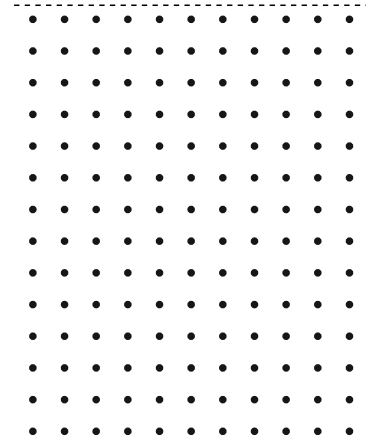

15

2017

rok metalowy M3 za dodatkową opłatą/  
metal element M3 extra paid  
43 x 69 mm

16

2017

43 x 11 mm

17

2017

32 x 21 mm

kryształem M5 za dodatkową opłatą/  
M5 cristal extra paid

18 **2017**

40 x 8 mm

19 **2017**

40 x 5 mm

20



99x 85 mm

krawędź oprawy/cover edge

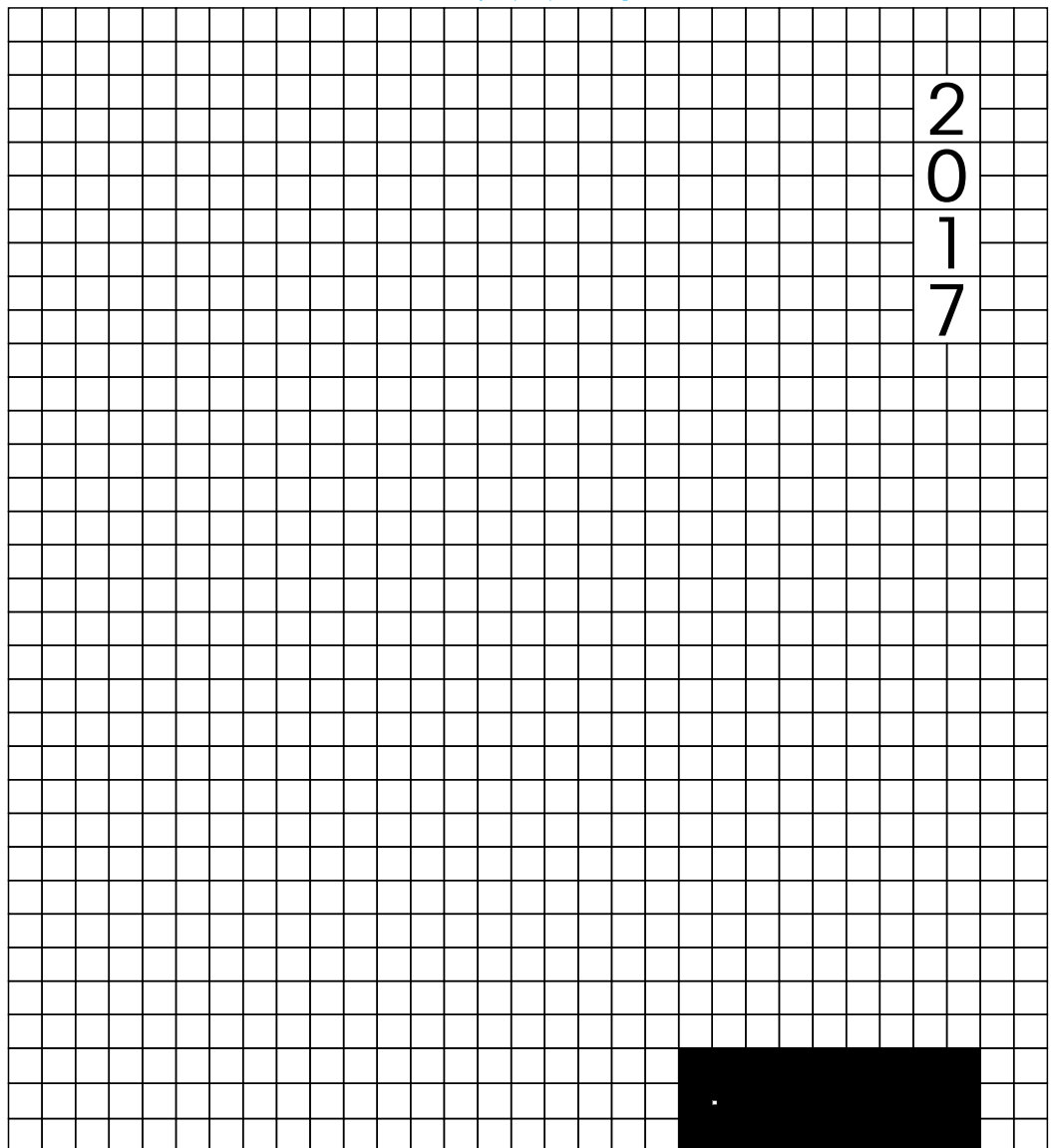

krawędź oprawy/cover edge

NEW DESIGN **N1**

Matryca w notesach występuje bez roku na kratce/ stamp in notebooks is without year  
 wysokość / height: 152 mm  
 szerokość kratki dostosowana do danej oprawy/ width of checked fit to cover size

Miejsce na blaszkę aluminiową M1/  
 place for aluminium element M1  
 blaszka za dopłatą/ metalplate extra

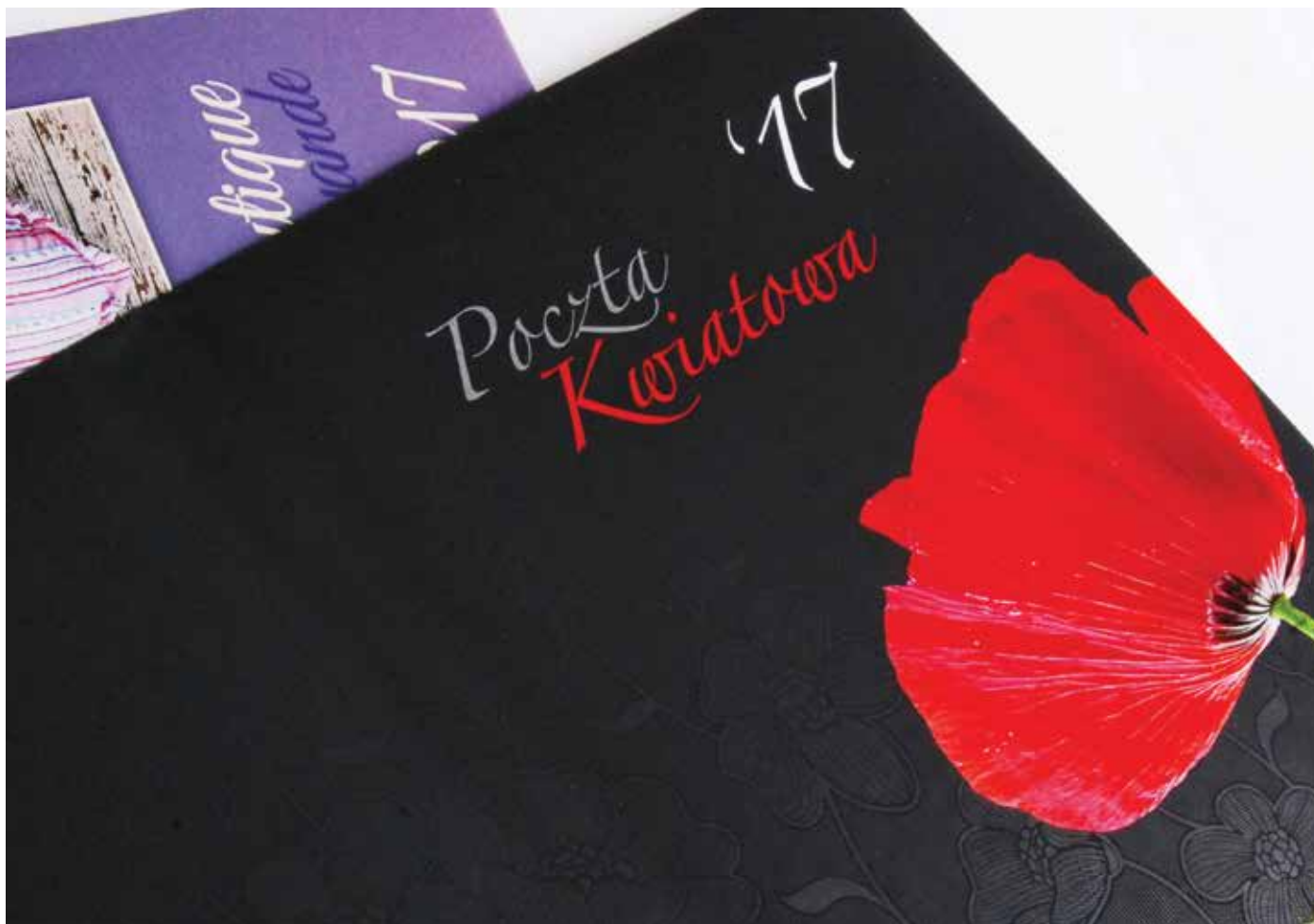

folia soft touch + UV  
soft touch foil + UV

farba matowa/  
matt paint



folia soft touch + UV  
soft touch foil + UV

farba matowa/  
matt paint



efekt skóra 3D + UV  
3d skin effect + UV

efekt skóry 3D/  
3d skin effect



UV błysk/ gloss

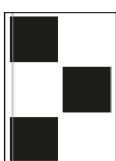

UV błysk/ gloss



UV błysk/ gloss

# stonebook®



EDYCJA LIMITOWANA  
KALENDARZY  
NOTESÓW  
NAPAPIERZEZKAMIENIA

LIMITED EDITION  
CALENDAR  
NOTEBOOKS  
ON STONE PAPER



\* gwarantujemy trwałość notates zapisanych długopisem, ołówkiem.  
\*we guarantee, that your notes will be safe, provided that you used ballpoint pen or pencil.







papiery z kamienia oszczędza naszej planecie:/  
of stone paper save out planet

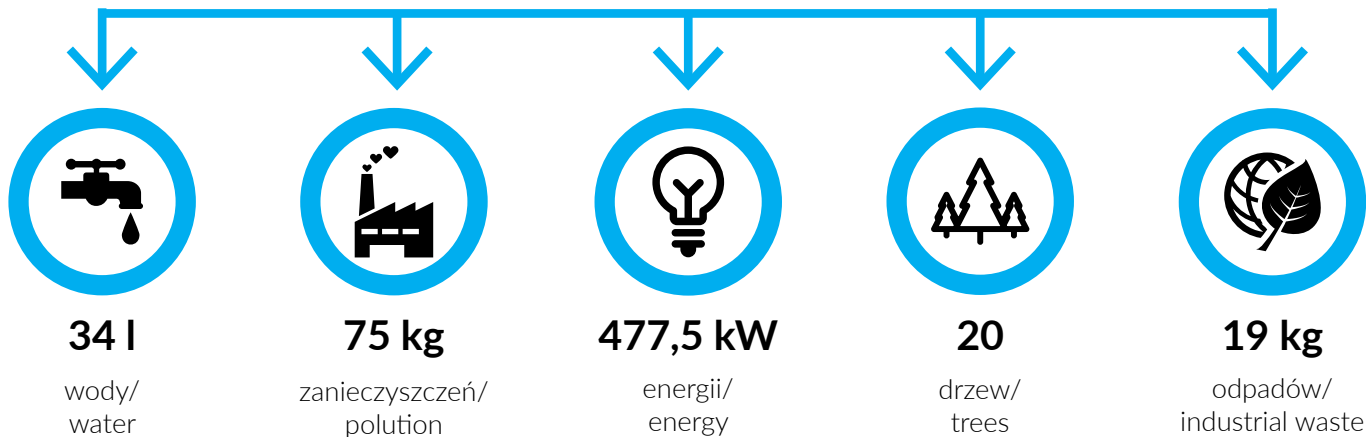

ZERO:



ZALETY PAPIERU Z KAMIENIA / BENEFITS OF STONE PAPER:



wodoodporny /  
waterproof

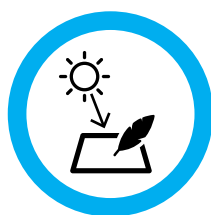

nie żółknie pod wpływem słońca,  
matowe wykończenie /  
no yellowing effect, matt finish

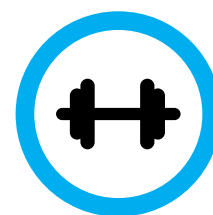

wytrzymały /  
durable

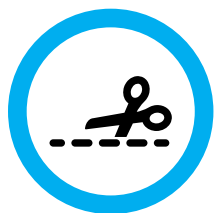

odporny na rozdarcia /  
tear-resistan

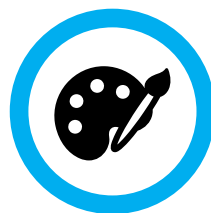

intensywne kolory druku /  
intensive printing colours

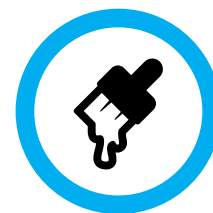

zużywa 30% mniej farby drukarskiej /  
printing uses 30% less paint

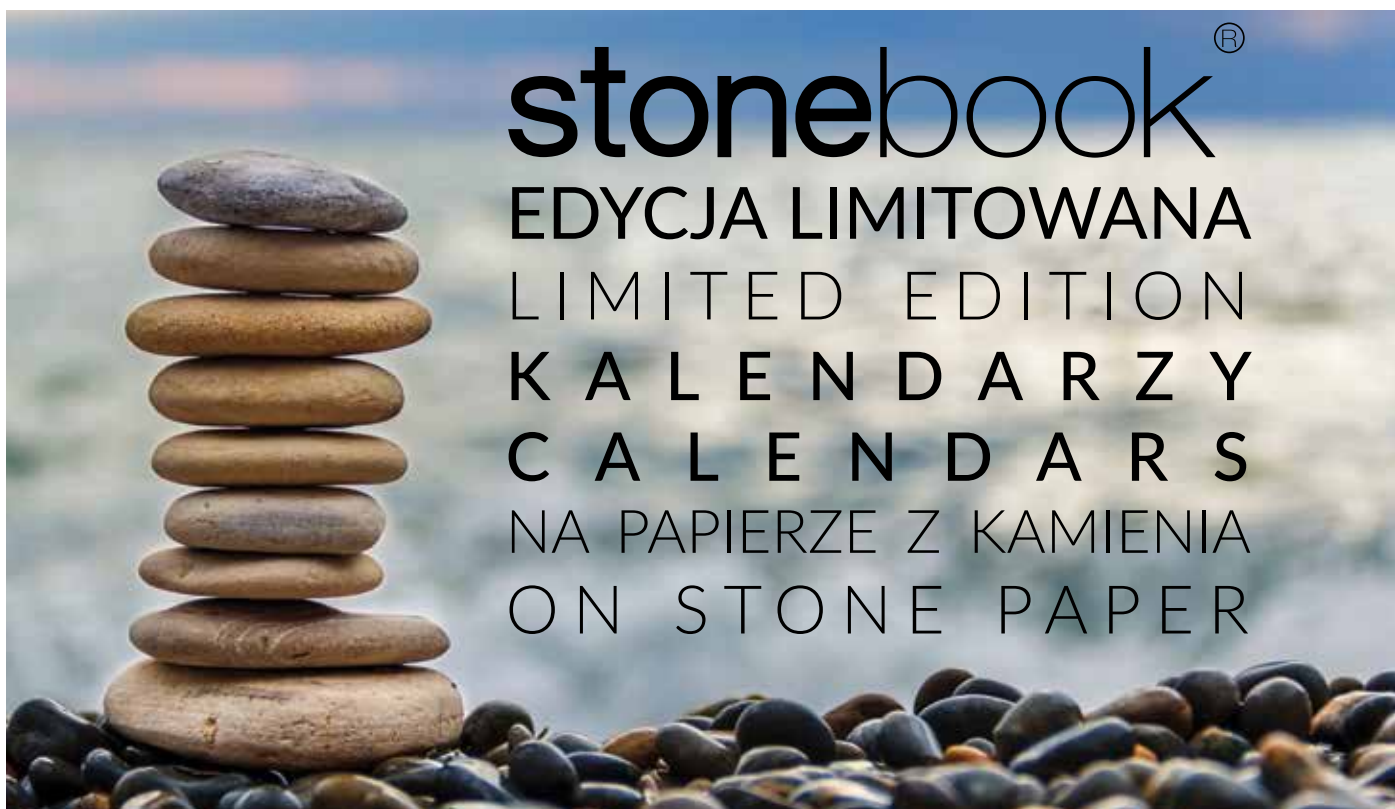

# 509T 149 x 203 mm

KALENDARZ + NOTES/ CALENDAR + NOTEBOOK

planer miesięczny/ yearly schedule

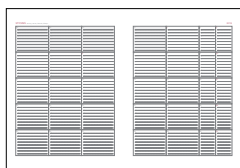

A5

new



- ilość stron:/ pages: 160
- kalendarz tygodniowy/ weekly calendar
- pięcioletnie kalendarium (polski, angielski, niemiecki, rosyjski, włoski)/ five languages (Polish, English, German, Russian, Italian)
- dane personalne/ personal data
- święta międzynarodowe/ international holidays
- kalendarz skrócony/ abridged calendar 2016-2018
- planowanie miesięczne/ yearly schedule
- imieniny/ name day
- fazy Księżyca/ moon phases
- znaki zodiaku/ zodiac signs
- notes teledresowy/ notes
- bez kolorowych map/ without colorfull maps
- bez perforacji/ without perforation



stonebook®

papier z kamienia/ stone paper  
drukowane registry/ print index

szaro-bordowy/ grey-maroon



# 511T 208 x 260 mm

KALENDARZ + NOTES/ CALENDAR + NOTEBOOK

planer miesięczny/ yearly schedule

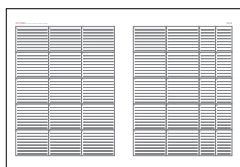

A4



- ilość stron:/ pages: 160
- kalendarz tygodniowy/ weekly calendar
- pięcioletnie kalendarium (polski, angielski, niemiecki, rosyjski, włoski)/ five languages (Polish, English, German, Russian, Italian)
- dane personalne/ personal data
- święta międzynarodowe/ international holidays
- kalendarz skrócony/ abridged calendar 2016-2018
- planowanie miesięczne/ yearly schedule
- imieniny/ name day
- fazy Księżyca/ moon phases
- znaki zodiaku/ zodiac signs
- bez kolorowych map/ without colorfull maps
- bez perforacji/ without perforation



stonebook<sup>o</sup>

papier z kamienia/ stone paper  
drukowane registry/ print index

szaro-bordowy/ grey-maroon



# 512T 167 x 240 mm

KALENDARZ + NOTES/ CALENDAR + NOTEBOOK

planer miesięczny/ yearly schedule

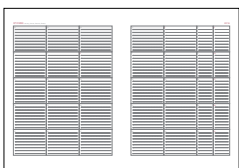

B5



- ilość stron:/ pages: 160
- kalendarz tygodniowy/ weekly calendar
- pięcioletnie kalendarium (polski, angielski, niemiecki, rosyjski, włoski)/ five languages (Polish, English, German, Russian, Italian)
- dane personalne/ personal data
- święta międzynarodowe/ international holidays
- kalendarz skrócony/ abridged calendar 2016-2018
- planowanie miesięczne/ yearly schedule
- imieniny/ name day
- fazy Księżyca/ moon phases
- znaki zodiaku/ zodiac signs
- notes teleadresowy/ notes
- bez kolorowych map/ without colorfull maps
- bez perforacji/ without perforation



stonebook<sup>o</sup>

papier z kamienia/ stone paper  
drukowane registry/ print index

szaro-bordowy/ grey-maroon



**FORMAT 513N**

167 x 240 mm

**MIĘDZYNARODOWY  
KALENDARZO-NOTES**

CALENDAR-NOTEBOOK

INTERNATIONAL

## SPECYFIKACJA / SPECIFICATION:

- format/ format: 167 x 240 mm
- kalendarz tygodniowy/ weekly calendar
- ilość stron: 160/ 160 pages
- wyklejka 1+0/ endpaper 1+0
- bez perforacji/ without perforation
- blok kalendarza nie zawiera żadnego języka/  
block without any language
- wklejka z kalendarzami w dowolnym języku (maks. 8 str.)/  
insert pages with calendar in any language (max. 8 pages)
- bez kolorowych map/ without colorfull maps

stonebook<sup>®</sup>papier z kamienia/ stone paper  
drukowane registry/ print index

szaro-szary/ grey-grey

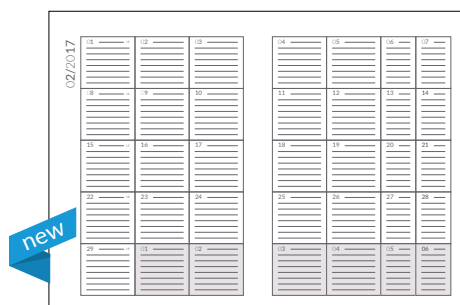

planer miesięczny/ montly schedule

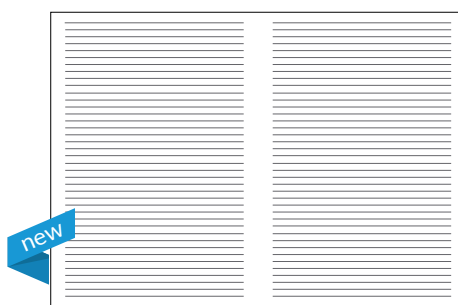

kartki notesu/ notebook sheets

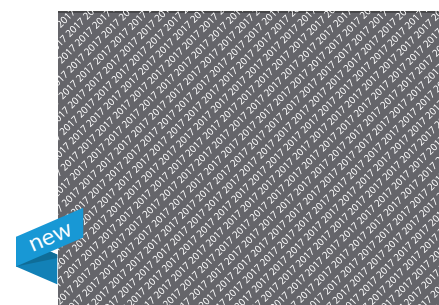

wyklejka/ endpaper

A5



layout stron z kalendarzem/ pages with calendar layout



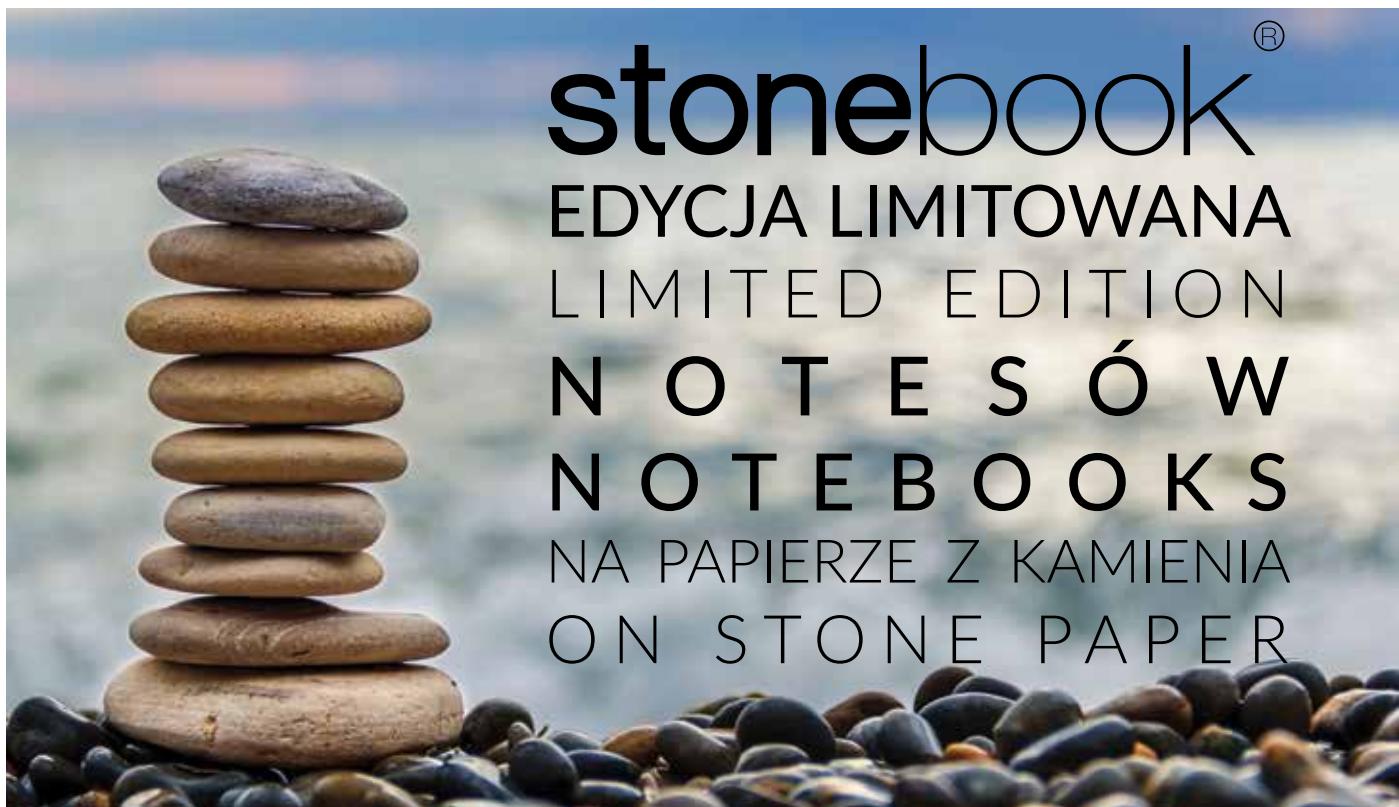

A5

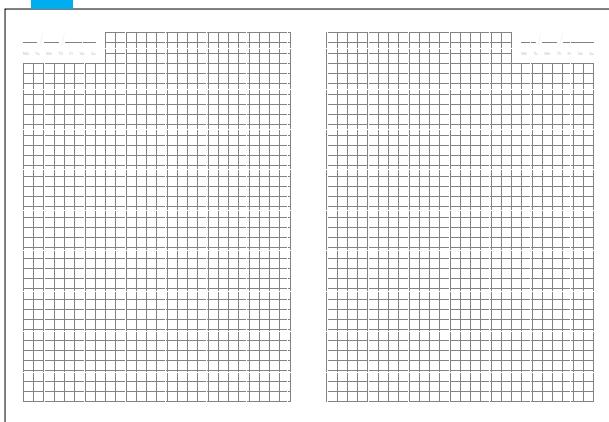

kratka/ checked

A5



linie/ lined

SPECYFIKACJA / SPECIFICATION:

- format notesu/ notebook format: 130 x 208 mm
- ilość stron: 148/ 148 pages
- papier biały z kamienia/ white stone paper 144 g
- wyklejka z papieru z kamienia/ stone paper endpaper
- bez perforacji/ without perforation



stonebook®

papier z kamienia/ stone paper
drukowane registry/ print index

szaro-szary/ grey- grey
-------------------------



A5

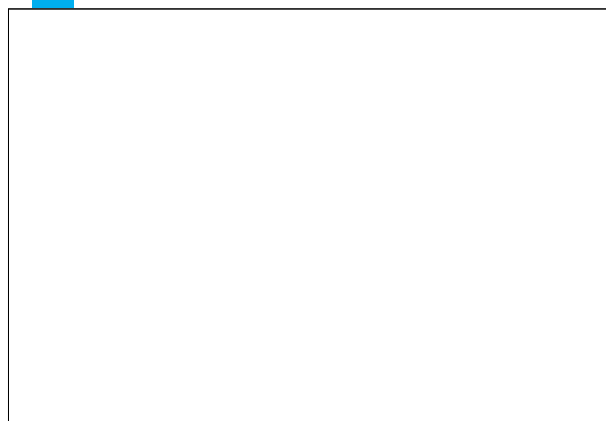

gładkie/ plain

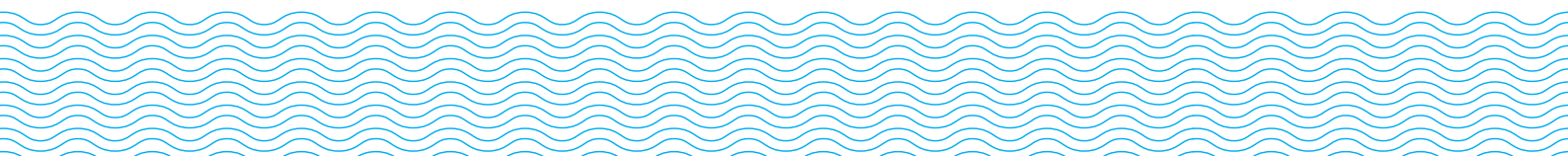

**OFFSET**
**510D** 143 x 203 mm

MIĘDZYNARODOWY  
K A L E N D A R Z  
I N T E R N A T I O N A L  
C A L E N D A R

- ilość stron:/ pages: 384
- kalendarz dzienny/ daily calendar
- perforacja narożników/ corner perforation
- pięcioletnie kalendarium (angielski, niemiecki, rosyjski, włoski, francuski)/ five languages (English, German, Russian, Italian, French)
- dane personalne/ personal data
- święta międzynarodowe/ international holidays
- kalendarz skrócony/ abridged calendar 2016-2018
- imieniny/ name day
- notes teledadresowy/ notes
- bez kolorowych map/ without colorfull maps

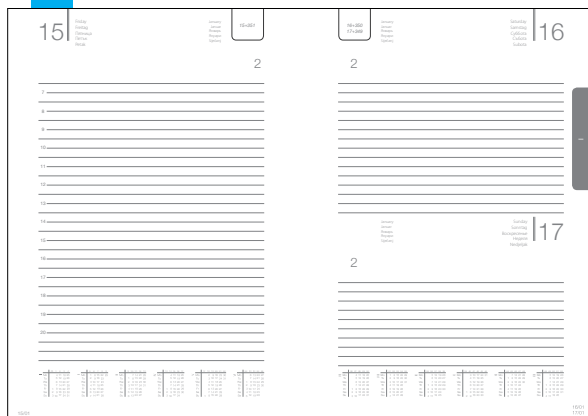
**A5**

szaro-szary/ grey-grey

 papier biały/ white paper  
 drukowane registry/ print index

# FORMAT 513N

167 x 240 mm

MIĘDZYNARODOWY

KALENDARZO-NOTES

CALENDAR-NOTEBOOK

INTERNATIONAL

SPECYFIKACJA / SPECIFICATION:

- format/ format: 167 x 240 mm
- kalendarz tygodniowy/ weekly calendar
- ilość stron: 160/ 160 pages
- wyklejka 1+0/ endpaper 1+0
- bez perforacji/ without perforation
- blok kalendarza nie zawiera żadnego języka/ block without any language
- wklejka z kalendarzami w dowolnym języku (maks. 8 str.)/ insert pages with calendar in any language (max. 8 pages)
- bez kolorowych map/ without colorfull maps

	papier biały/ white paper
	drukowane registry/ print index
szaro-szary/ grey-grey	<input checked="" type="checkbox"/>



new

planer miesięczny/ montly schedule



new

kartki notesu/ notebook sheets

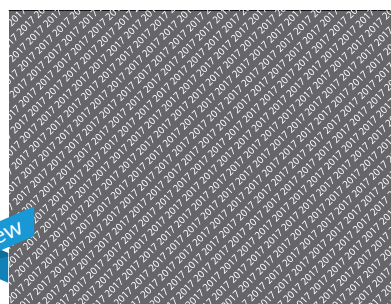

new

wyklejka/ endpaper



new

layout stron z kalendarzem/ pages with calendar layout



OFFSET

# 501D 200 x 280 mm

KALENDARZ DZIENNY/ DAILY CALENDAR

planer miesięczny/ yearly schedule

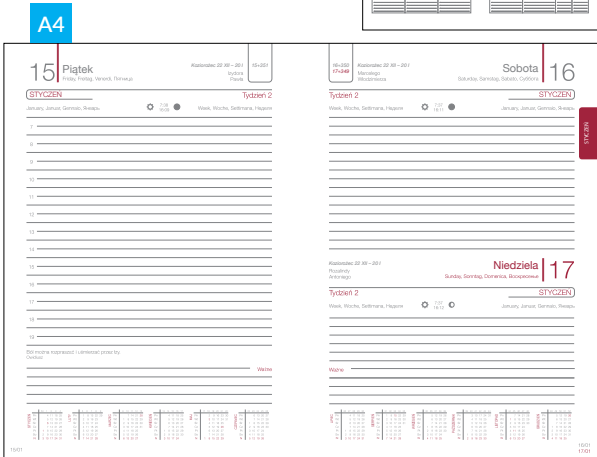

- ilość stron:/ pages: 384
- kalendarz dzienny/ daily calendar
- perforacja narożników/ corner perforation
- pięcioletnie kalendarium (polski, angielski, niemiecki, rosyjski, włoski)/ five languages (Polish, English, German, Russian, Italian)
- dane personalne/ personal data
- święta międzynarodowe /international holidays
- kalendarz skrócony/ abridged calendar 2016-2018
- planowanie miesięczne/ yearly schedule
- imieniny/ name day
- fazy Księżyca/ moon phases
- znaki zodiaku/ zodiac signs
- aforyzmy/ aphorism
- kalendarz wieczny/ perpetual calendar
- miary i wagi/ weights and measures
- odległości pomiędzy wybranymi miastami Polski/ distances
- strefy czasowe/time zones
- telefoniczne numery kierunkowe (Świat i Polska)/ telephone area codes (World and Poland)
- ważne telefony/ important telephone numbers
- wspólne oświadczenie o zdarzeniu drogowym/ Accident statement
- notes teleadresowy/ notes
- 8 strony kolorowych map/ 8 with maps in full colour
  - Europa/ Europe
  - Polska/ Poland
  - Niemcy/ Germany
  - Czechy i Słowacja/ Czech & Slovakia
  - podział administracyjny Polski/ Political map of Poland

	papier biały/ white paper		papier chamois/ beige paper	
	drukowane registry/ print index	wycinane registry/ index cut	drukowane registry/ print index	wycinane registry/ index cut
szaro-bordowy/ grey-maroon	✓	✓	✓	✓
szaro-granatowy/ grey-dark blue	✓	✓	✓	✓



# 502T 208 x 260 mm

KALENDARZ TYGODNIOWY/ WEEKLY CALENDAR

planer miesięczny/yearly schedule

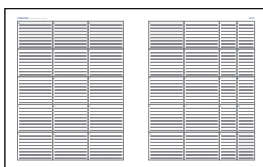

A4



- ilość stron:/ pages: 160
- kalendarz tygodniowy/ weekly calendar
- perforacja narożników/ corner perforation
- pięcioletnie kalendarium (polski, angielski, niemiecki, rosyjski, włoski)/ five languages (Polish, English, German, Russian, Italian)
- dane personalne/ personal data
- święta międzynarodowe/ international holidays
- kalendarz skrócony/ abridged calendar 2016-2018
- planowanie miesięczne/ yearly schedule
- imieniny/ name day
- fazy Księżyca/ moon phases
- znaki zodiaku/ zodiac signs
- aforyzmy/ aphorism
- kalendarz wieczny/ perpetual calendar
- miary i wagi/ weights and measures
- odległości pomiędzy wybranymi miastami Polski/ distances
- strefy czasowe/ time zones
- telefoniczne numery kierunkowe (Świat i Polska)/ telephone area codes (World and Poland)
- ważne telefony/ important telephone numbers
- wspólne oświadczenie o zdarzeniu drogowym/ Accident statement
- notes teled adresowy/ notes
- 8 strony kolorowych map/ 8 with maps in full colour
  - Europa/ Europe
  - Polska/ Poland
  - Niemcy/ Germany
  - Czechy i Słowacja/ Czech & Slovakia
  - podział administracyjny Polski/ Political map of Poland

	papier biały/ white paper		papier chamois/ beige paper	
	drukowane registry/ print index	wycinane registry/ index cut	drukowane registry/ print index	wycinane registry/ index cut
szaro-bordowy/ grey-maroon	✓	✓	✓	✓
szaro-granatowy/ grey-dark blue	✓	✓	✓	✓

# 503D 143 x 203 mm

KALENDARZ DZIENNY/ DAILY CALENDAR

planer miesięczny/yearly schedule

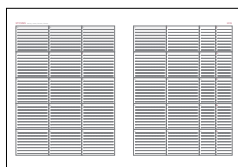

A5

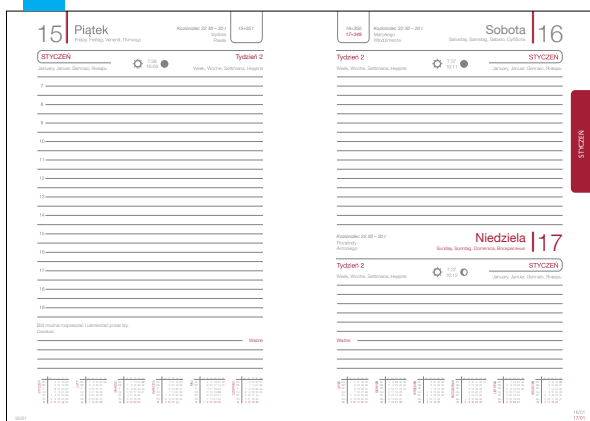

- ilość stron:/ pages: 384
- kalendarz dzienny/ daily calendar
- perforacja narożników/ corner perforation
- pięcioletnie kalendarium (polski, angielski, niemiecki, rosyjski, włoski)/ five languages (Polish, English, German, Russian, Italian)
- dane personalne/ personal data
- święta międzynarodowe/ international holidays
- kalendarz skrócony/ abridged calendar 2016-2018
- planowanie miesięczne/ yearly schedule
- imieniny/ name day
- fazy Księżyca/ moon phases
- znaki zodiaku/ zodiac signs
- aforyzmy/ aphorism
- kalendarz wieczny/ perpetual calendar
- miary i wagi/ weights and measures
- odległości pomiędzy wybranymi miastami Polski/ distances
- strefy czasowe/ time zones
- telefoniczne numery kierunkowe (Świat i Polska)/ telephone area codes (World and Poland)
- ważne telefony/ important telephone numbers
- wspólne oświadczenie o zdarzeniu drogowym/ Accident statement
- notes teled adresowy/ notes
- 4 strony kolorowych map/ 4 with maps in full colour
  - Europa/ Europe
  - Polska/ Poland
  - podział administracyjny Polski/ Political map of Poland

	papier biały/ white paper		papier chamois/ beige paper	
	drukowane registry/ print index	wycinane registry/ index cut	drukowane registry/ print index	wycinane registry/ index cut
szaro-bordowy/ grey-maroon	✓	✓	✓	✓
szaro-granatowy/ grey-dark blue	✓	✓	✓	✓

**504T** 85 x 153 mm

KALENDARZ KIESZONKOWY/ POCKET CALENDAR

- ilość stron:/ pages: 128
- kalendarz tygodniowy/ week calendar
- brak perforacji/ without perforation
- pięcioletnie kalendarium (polski, angielski, niemiecki, rosyjski, włoski)/ five languages (Polish, English, German, Russian, Italian)
- dane personalne/ personal data
- święta międzynarodowe/ international holidays
- kalendarz skrócony/ abridged calendar 2016-2018
- imieniny/ name day
- telefoniczne numery kierunkowe (Świat i Polska)/ telephone area codes (World and Poland)
- notes teleadresowy/ notes
- bez kolorowych map/ without colorfull maps

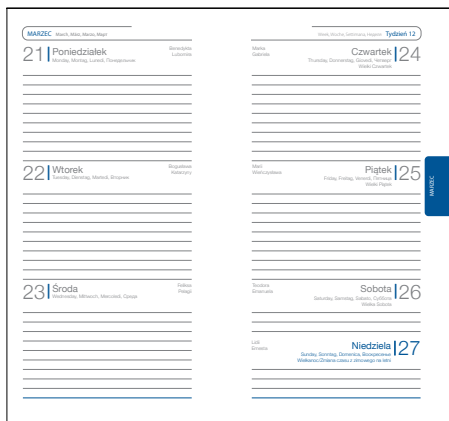

	papier biały/ white paper	papier chamois/ beige paper
	drukowane registry/ print index	drukowane registry/ print index
szaro-bordowy/ grey-maroon	✓	✓
szaro-granatowy/ grey-dark blue	✓	✓

**505T** 105 x 297 mm

KALENDARZ BIURKOWY/ DESK CALENDAR

LEŻĄCY LUB STOJĄCY / RELUMBENT OR STANDING

- ilość stron:/ pages: 128
- kalendarz tygodniowy/ week calendar
- pięcioletnie kalendarium (polski, angielski, niemiecki, rosyjski, włoski)/ five languages (Polish, English, German, Russian, Italian)
- dane personalne/ personal data
- święta międzynarodowe/ international holidays
- kalendarz skrócony/ abridged calendar 2016-2018
- imieniny/ name day
- fazy Księżycy/ moon phases
- aforyzmy/ aphorism
- kalendarz wieczny/ perpetual calendar
- miary i wagi/ weights and measures
- notes teleadresowy/ notebook numbers and adress
- notes na spirali/ spiral binding
- rogi okładki - proste/ square cover corners

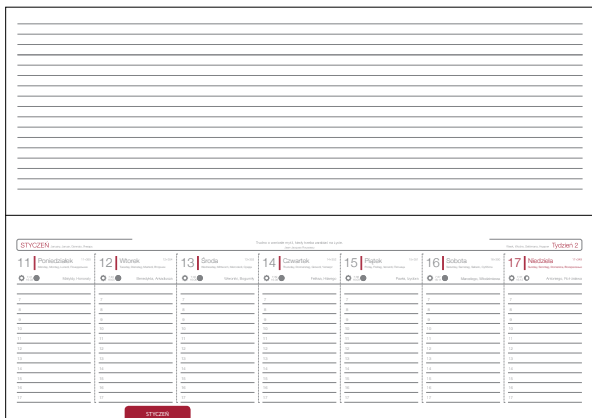
kalendarz leżący/  
relumbentkalendarz stojący/  
standing

	papier biały/ white paper	papier chamois/ beige paper
kolor druku/ print colour	drukowane registry/ print index	drukowane registry/ print index
szaro-bordowy/ grey-maroon	✓	✓
szaro-granatowy/ grey-dark blue	✓	✗

# 506D 110 x 160 mm

KALENDARZ DZIENNY/ DAILY CALENDAR

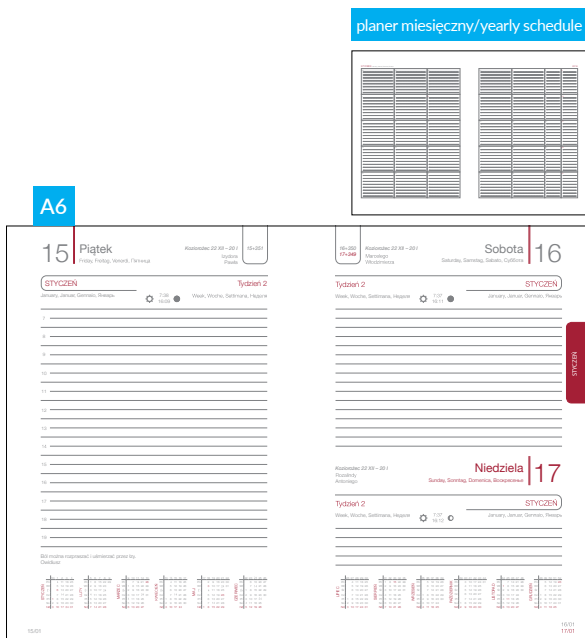

- ilość stron:/ pages: 368
- kalendarz dzienny/ daily calendar
- brak perforacji/ without perforation
- pięcioletnie kalendarium (polski, angielski, niemiecki, rosyjski, włoski) / five languages (Polish, English, German, Russian, Italian)
- dane personalne/ personal data
- święta międzynarodowe/ international holidays
- kalendarz skrócony/ abridged calendar 2016-2018
- imieniny/ name day
- fazy Księżyca/ moon phases
- znaki zodiaku/ zodiac signs
- aforyzmy/ aphorism
- kalendarz wieczny/ perpetual calendar
- miary i wagi/ weights and measures
- odległości pomiędzy wybranymi miastami Polski/distances
- strefy czasowe/ time zones
- telefoniczne numery kierunkowe (Świat i Polska)/ telephone area codes (World and Poland)
- ważne telefony/ important telephone numbers
- wspólne oświadczenie o zdarzeniu drogowym/ Accident statement
- notes teled adresowy/ notes
- 4 strony kolorowych map/ 4 with maps in full colour
  - Europa/ Europe
  - Polska/ Poland
  - podział administracyjny Polski/ Political map of Poland

papier biały/ white paper	
drukowane registry/ print index	
szaro-bordowy/ grey-maroon	✓

# 507T 167 x 240 mm

KALENDARZ TYGODNIOWY / WEEKLY CALENDAR

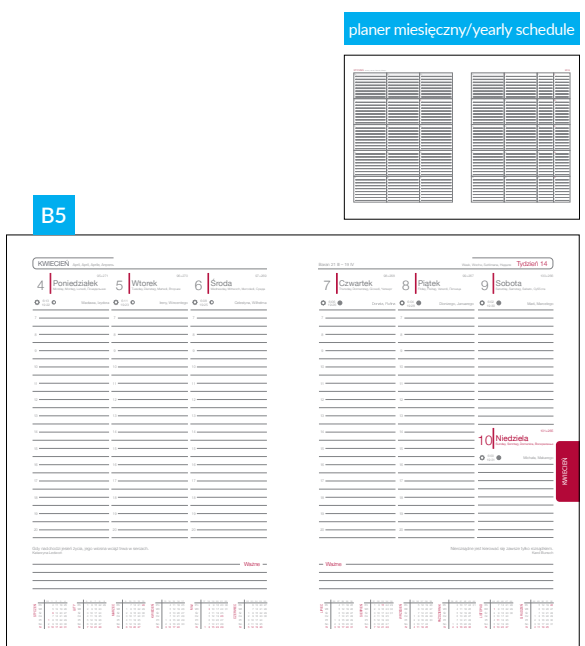

- ilość stron:/ pages: 160
- kalendarz tygodniowy/ weekly calendar
- perforacja narożników/ corner perforation
- pięcioletnie kalendarium (polski, angielski, niemiecki, rosyjski, włoski) / five languages (Polish, English, German, Russian, Italian)
- dane personalne/ personal data
- święta międzynarodowe/ international holidays
- kalendarz skrócony/ abridged calendar 2016-2018
- planowanie miesięczne/ yearly schedule
- imieniny/ name day
- fazy Księżyca/ moon phases
- znaki zodiaku/ zodiac signs
- aforyzmy/ aphorism
- kalendarz wieczny/ perpetual calendar
- miary i wagi/ weights and measures
- odległości pomiędzy wybranymi miastami Polski/ distances
- strefy czasowe/ time zones
- telefoniczne numery kierunkowe (Świat i Polska)/ telephone area codes (World and Poland)
- ważne telefony/ important telephone numbers
- wspólne oświadczenie o zdarzeniu drogowym/Accident statement
- notes teled adresowy/ notes
- 8 strony kolorowych map/ 8 with maps in full colour
  - Europa/ Europe
  - Polska/ Poland
  - Niemcy/ Germany
  - Czechy i Słowacja/ Czech & Slovakia
  - podział administracyjny Polski/ Political map of Poland

	papier biały/ white paper		papier chamois/ beige paper	
	drukowane registry/ print index	wycinane registry/ index cut	drukowane registry/ print index	wycinane registry/ index cut
szaro-bordowy/ grey-maroon	✓	✓	✓	✓
szaro-granatowy/ grey-dark blue	✓	✓	✓	✓

# 508D 162 x 240 mm

KALENDARZ DZIENNY/ DAILY CALENDAR

planer miesięczny/ yearly schedule

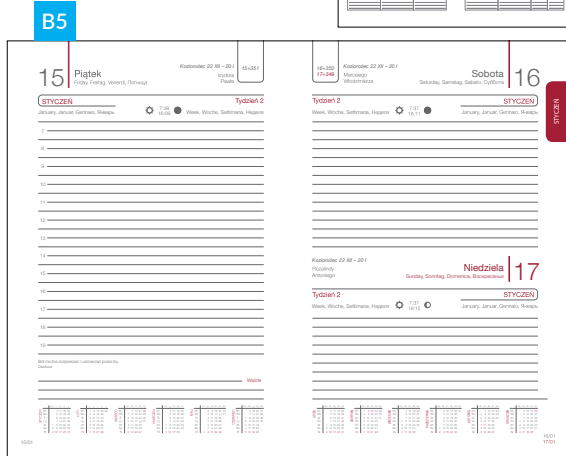
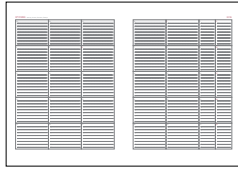

- ilość stron:/ pages: 384
- kalendarz dzienny/ daily calendar
- perforacja narożników/ corner perforation
- pięcioletnie kalendarium (polski, angielski, niemiecki, rosyjski, włoski)/ five languages (Polish, English, German, Russian, Italian)
- dane personalne/ personal data
- święta międzynarodowe/ international holidays
- kalendarz skrócony/ abridged calendar 2016-2018
- planowanie miesięczne/ yearly schedule
- imieniny/ name day
- fazy Księżyca/ moon phases
- znaki zodiaku/ zodiac signs
- aforyzmy/ aphorism
- kalendarz wieczny/ perpetual calendar
- miary i wagi/ weights and measures
- odległości pomiędzy wybranymi miastami Polski/ distances
- strefy czasowe/ time zones
- telefoniczne numery kierunkowe (Świat i Polska)/ telephone area codes (World and Poland)
- ważne telefony/ important telephone numbers
- wspólne oświadczenie o zdarzeniu drogowym/ Accident statement
- notes teledadresowy/ notes
- 8 strony kolorowych map/ 8 with maps in full colour
  - Europa/ Europe
  - Polska/ Poland
  - Niemcy/ Germany
  - Czechy i Słowacja/ Czech & Slovakia
  - podział administracyjny Polski/ Political map of Poland

	papier biały/ white paper		papier chamois/ beige paper	
	drukowane registry/ print index	wycinane registry/ index cut	drukowane registry/ print index	wycinane registry/ index cut
szaro-bordowy/ grey-maroon	✓	✓	✓	✓
szaro-granatowy/ grey-dark blue	✓	✓	✓	✓

# 509T 149 x 203 mm

KALENDARZ + NOTES/ CALENDAR + NOTEBOOK

planer miesięczny/ yearly schedule

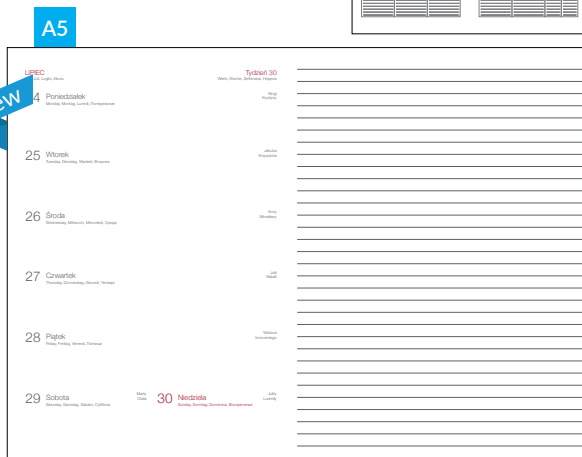
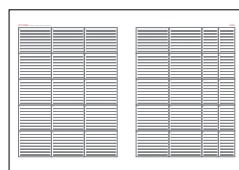

- ilość stron:/ pages: 160
- kalendarz tygodniowy/ weekly calendar
- brak perforacji/ without perforation
- pięcioletnie kalendarium (polski, angielski, niemiecki, rosyjski, włoski)/ five languages (Polish, English, German, Russian, Italian)
- dane personalne/ personal data
- święta międzynarodowe/ international holidays
- kalendarz skrócony/ abridged calendar 2016-2018
- planowanie miesięczne/ yearly schedule
- imieniny/ name day
- fazy Księżyca/ moon phases
- znaki zodiaku/ zodiac signs
- notes teledadresowy/ notes
- bez kolorowych map/ without colorfull maps

	papier biały/ white paper	papier chamois/ beige paper
	drukowane registry/ print index	drukowane registry/ print index
szaro-bordowy/ grey-maroon	✓	✓

# 511T 208 x 260 mm

KALENDARZ + NOTES/ CALENDAR + NOTEBOOK

planer miesięczny/ yearly schedule

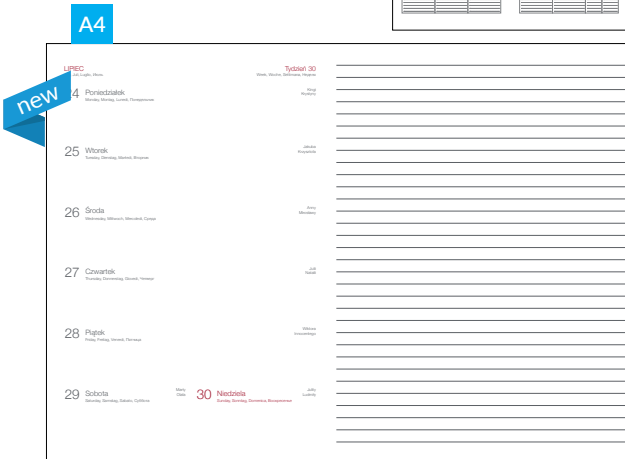
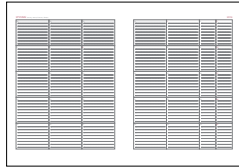

- ilość stron:/ pages: 160
- kalendarz tygodniowy/ week calendar
- brak perforacji/ without perforation
- pięcioletnie kalendarium (polski, angielski, niemiecki, rosyjski, włoski)/ five languages (Polish, English, German, Russian, Italian)
- dane personalne/ personal data
- święta międzynarodowe/ international holidays
- kalendarz skrócony/ abridged calendar 2016-2018
- planowanie miesięczne/ yearly schedule
- imieniny/ name day
- fazy Księżyca/ moon phases
- znaki zodiaku/ zodiac signs
- bez kolorowych map/ without colorfull maps

	papier biały/ white paper	papier chamois/ beige paper
	drukowane registry/ print index	drukowane registry/ print index
szaro-bordowy/ grey-maroon	✓	✓

# 512T 167 x 240 mm

KALENDARZ + NOTES/ CALENDAR + NOTEBOOK

planer miesięczny/ yearly schedule

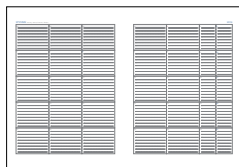

- ilość stron:/ pages: 160
- kalendarz tygodniowy/ weekly calendar
- pięcioletnie kalendarium (polski, angielski, niemiecki, rosyjski, włoski)/ five languages (Polish, English, German, Russian, Italian)
- dane personalne/ personal data
- święta międzynarodowe/ international holidays
- kalendarz skrócony/ abridged calendar 2016-2018
- planowanie miesięczne/ yearly schedule
- imieniny/ name day
- fazy Księżyca/ moon phases
- znaki zodiaku/ zodiac signs
- notes teleadresowy/ notes
- bez kolorowych map/ without colorfull maps

	papier biały/ white paper	papier chamois/ beige paper
	drukowane registry/ print index	drukowane registry/ print index
szaro-granatowy/ grey-dark blue	✓	✓

# FORMAT A6

## 105 x 140 mm

- format/format: 105 x 140 mm
- ilość stron: 192/ 192 pages
- biały offset/ white offset paper 80 g
- wyklejka biała/ white endpaper
- bez perforacji/ without perforation

A6

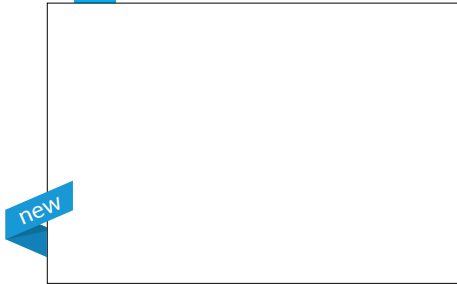

gładkie/ plain

A6

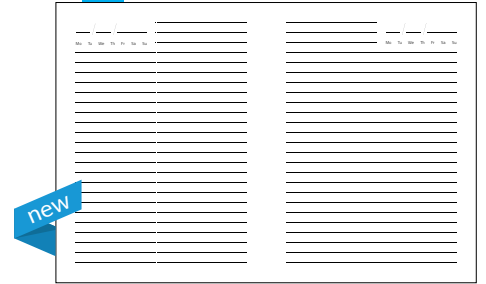

linie/ lined

A6

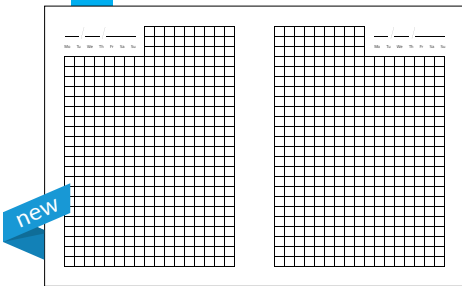

kratka/checked



POLECAMY/WE RECOMMEND

ZESTAW UPOMINKOWY:  
Notes 105x140 mm + długopis crystallo  
GIFT SET:  
Notebook 105 x 140 + ballpoint pen crystallo

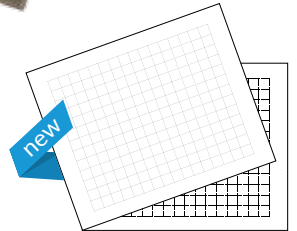

# FORMAT A4

## 208 x 260 mm

- format/ format: 208x260 mm
- ilość stron: 176 + 16 z perforacją/  
176 pages + 16 pages with perforation
- biały offset/ white offset paper 80 g
- wyklejka biała/ white endpaper

A4

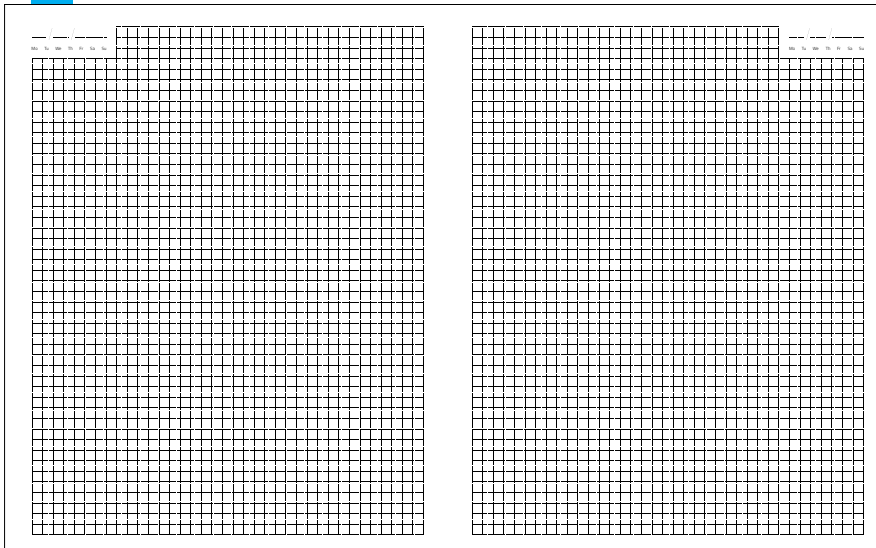

kratka/ checked

PERFORACJA/PERFORATION

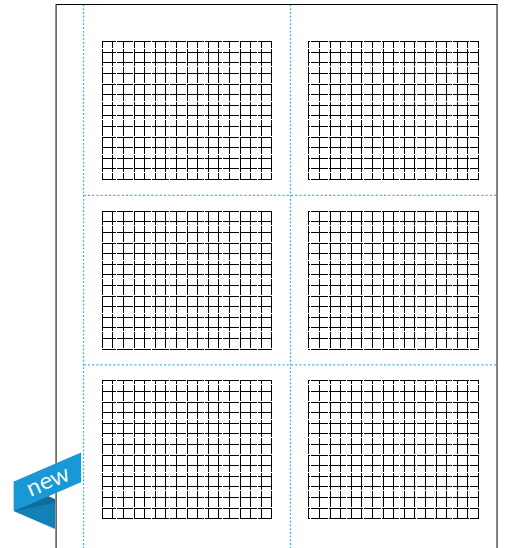
strony z perforacją/  
pages with perforation

# FORMAT A5

## 130 x 208 mm

- format/ format: 130 x 208 mm
- ilość stron: 176 + 16 z perforacją/  
176 pages + 16 pages with perforation
- biały offset/ white offset paper 80 g
- wyklejka biała/ white endpaper

A5

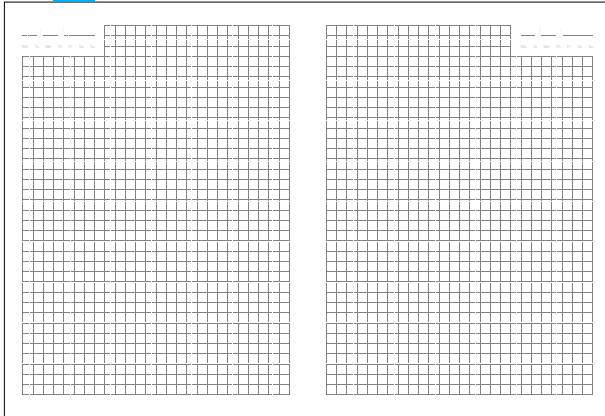

kratka/ checked

A5



linie/ lined

A5

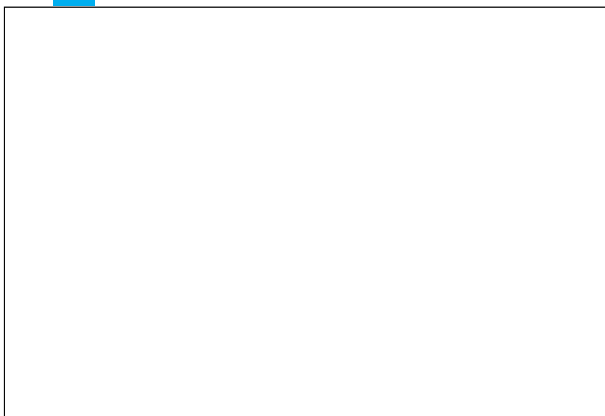

gładkie/ plain

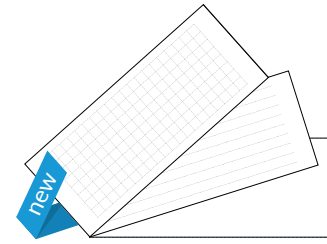

PERFORACJA/PERFORATION

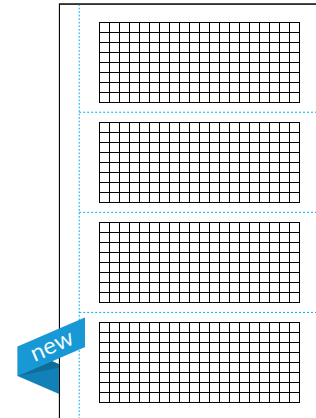
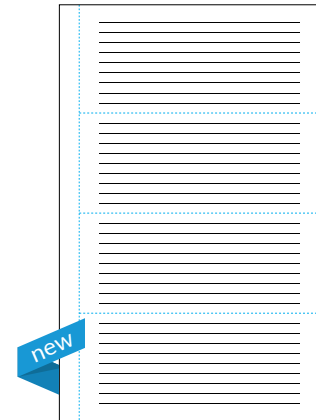
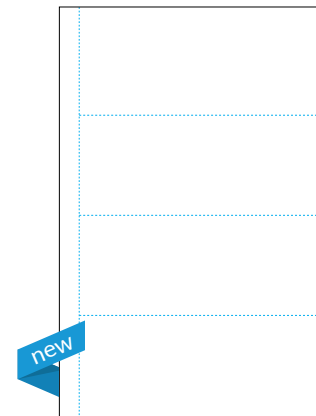
strony z perforacją/  
pages with perforationstrony z perforacją/  
pages with perforationstrony z perforacją/  
pages with perforation

## KALENDARZ DZIENNY / DAILY CALENDAR

	ilość stron number of pages	format bloku block format	papier / paper			planer miesięczny monthly planner	perforacja perforation	mapy maps
			biały offset white offset	chamois offset chamois offset	papier z kamienia stone paper			
<b>501</b>	384	200x280 mm	✓	✓		✓	✓	✓
<b>503</b>	384	143x203 mm	✓	✓		✓	✓	✓
<b>506</b>	368	110x160 mm	✓	✓				✓
<b>508</b>	384	162x240 mm	✓	✓		✓	✓	✓

## KALENDARZ TYGODNIOWY / WEEKLY CALENDAR

	ilość stron number of pages	format bloku block format	papier / paper			planer miesięczny monthly planner	perforacja perforation	mapy maps
			biały offset white offset	chamois offset chamois offset	papier z kamienia stone paper			
<b>502</b>	160	208x260 mm	✓	✓		✓	✓	✓
<b>507</b>	160	167x240 mm	✓	✓		✓	✓	✓
<b>504</b>	128	85x153 mm	✓	✓				

## KALENDARZ + NOTES / CALENDAR + NOTEBOOK

	ilość stron number of pages	format bloku block format	papier / paper			planer miesięczny monthly planner	perforacja perforation	mapy maps
			biały offset white offset	chamois offset chamois offset	papier z kamienia stone paper			
<b>505</b>	128	105x297 mm	✓	✓				
<b>509</b>	160	149x203 mm	✓	✓	✓	✓		
<b>511</b>	160	208x260 mm	✓		✓	✓		
<b>512</b>	160	167x260 mm	✓		✓	✓		

## KALENDARZ MIĘDZYNARODOWY / INTERNATIONAL CALENDAR

	ilość stron number of pages	format bloku block format	papier / paper			planer miesięczny monthly planner	perforacja perforation	mapy maps
			biały offset white offset	chamois offset chamois offset	papier z kamienia stone paper			
<b>510</b>	384	143x203 mm	✓			✓		
<b>513</b>	160	167x240 mm	✓		✓	✓		